



# Computer-Aided Diagnosis Psoriasis Lesion Using Skin Color and Texture Features

Tanya Shakir Jarad<sup>1</sup> and Ali J. Dawood<sup>1</sup>

<sup>1</sup> Department of Computer Science, College of Computer Science and Information Technology, University of Anbar, Anbar, Iraq

Received 31 Dec. 2017, Revised 30 Jan. 2018, Accepted 20 Mar. 2018, Published 1 May 2018

**Abstract:** Psoriasis form out to be one of the weakening and persisting incendiary skin lesions. Frequently confused as a casual skin thickness, it is evaluated that around 125 million individuals overall endures because of this disease. The case is exacerbated when there is no known cure in the status norm. The common classification of psoriasis has been considered as unexpectedly separated scaly and erythematous plaque at patient's skin. This lesion could follow anyplace on the human body. **Objectives:** Diagnosis of psoriasis requires an experienced specialist in the field of dermatology which lead to majority cases of an error in diagnosis, incorrect disease identification is highly possible and there is no consensus on the current subjective assessment methods due to the unavoidable inter and intra- observer variances. The purpose of this study is to establish a diagnosis system of psoriasis lesion to ease the role of the physician in diagnosis by providing better and more reliable results, to support the expert's decision to diagnose the lesion, especially doctors with little experience. **Methods:** In this paper, the researcher is interested in the diagnosis psoriasis lesion by using color and texture features by finding the new sign (color and texture features) implementation to support the expert decision. Aggregate 200 image samples of psoriasis patients are used in our database. Machine learning using Artificial Neural Network classifier ANN to obtain optimized performance. **Result:** CADP system shows optimal performance of 100% accuracy, 100% sensitivity and 100% specificity for color-texture feature with RGB-Local Binary Pattern method and performance of 100% accuracy, 100% sensitivity and 100% specificity with the RGB Color Co-occurrence Matrix method. **Conclusions:** CAD system became a tool for physicians and therefore it is important to have accurate and reliable CAD system. The LBP and CCM texture features are powerful in psoriasis disease classification for RGB color images.

**Keywords:** Classification, Color feature, Texture features, Color-texture feature, Psoriasis lesion disease, Healthy skin

## 1. INTRODUCTION

Psoriasis is a constant skin disease influencing around 125 million individuals overall [1]. The predominance of psoriasis in various topographical areas, for example, Europe, USA, Malaysia and India are around 0.6% to 6.5% [2], 3.15% [2], 3% [3] and 1.02% [4], respectively. It can impact the patients' personal satisfaction because of its humiliating physical appearance [5]. This outcome in expanded danger of thinking about suicide (~30%) which makes it a similarly hazardous sickness at standard with misery, coronary illness and diabetes [6]. Psoriasis shows up in an assortment of structures, specifically plaque, guttate, inverse, pustular, and erythrodermic. In 80% of the cases, plaque is observed to be the most widely recognized types of psoriasis [7] and in this manner the work displayed in this paper is engaged five sorts of psoriasis lesion. Dermatologists by and large take after visual examination and the feeling of touch to anticipate the seriousness which requires talented preparing for

better determination and investigation. Still the subjective appraisal is wasteful, unreliable and a difficult procedure. Subsequently, a computer-aided diagnosis (CADx) system could be valuable in clinical applications. Throughout the years, researchers created a considerable lot of CADx systems for the diagnosis of different skin lesions pictures.

In the introduced study, the goal is to psoriatic the psoriasis CAD a system utilizing distinctive different feature sets, i.e., texture features with two algorithms, 30 Color Co-occurrence Matrix (CCM) and 216 Local Binary Pattern (LBP) and 256 Colour Histogram feature. By and large, we have shaped three arrangements of feature: (i) Color Histogram independent (F1); (ii) Texture CCM by itself (F2) and (iii) Texture LBP by itself (F3). These features enter into ANN and classify as independently the machine learning system performs the best with more feature. Alongside the previously mentioned objective, in this paper brings the number of contributions: (i) to the best of our insight, first time

RGB-LBP texture features have been extracted from psoriasis lesion images. The irregular distribution of pixels of psoriatic lesions and nonlinear conduct among the frequency parts, innovates us to utilize the RGB-LBP texture features; (ii) biggest arrangement of mathematical features ever computed in a psoriasis skin infection system comprising of 502 features including color-texture LBP and CCM and Color Histogram feature; (iii) Joint color-texture features, the LBP operator and CCM are connected on each colour band independently. In addition, each combines of colour bands. The findings texture descriptor is six times longer than the grayscale level, which may make it unusable in a few applications, however includes extracted from psoriasis lesion pictures were extremely promising.

## 2. RELATED WORK

In diagnosis of skin lesions using image processing the important task is to detect the skin. In addition, The artificial neural networks can be effectively used to work with medical images in correct skin lesion diagnosis. *Shrivastava et al [9]* the proposed CADx system has been in to automatically classify images into psoriatic lesion and healthy skin using color and texture features and classification by SVM algorithm. **2002, Michael J. Jones et al [11]**: Proposed compare the performance of the histogram and a mixture of Gaussian models in skin diagnosis and find histogram models to be prevalent in precision and cost for skin diagnosis had been computed. **2010, Nidhal K. Abbadi et al [12]**: Created system for psoriasis diagnosis utilizing color and texture features. The objective of these works it to assess the capacity of the proposed skin texture recognition algorithm to distinguish amongst lesion and healthy skins and they took the psoriasis lesion as a case. **2015, Miss. Priyanka s. Biradar et al [14]**: Proposed computer aided skin disease diagnosis system developed. Using extracted colour (Mean and Standard Deviations of the 3-color channels (R, G and B) of diseased skin) and texture (Energy, Entropy and Contrast in each color channel) features of psoriasis image and applied Neural Network for classification. **2016, Vimal K. Shrivastava1 et al [15]**: Proposed CADx system for psoriasis risk stratification and image classification utilizing as novelties HOS feature in addition to the other texture and color features and classification with SVM. The CADx framework accomplished ideal execution of 100% sensitivity, 100% accuracy and specificity, but in this system used very complex mathematical operations that required time consuming of process to classify normal vs. abnormal cases.

## 3. MATERIALS AND METHODS

### A. Materials

In this research work, we have gathered colored imageries from the psoriasis section of Ramadi teaching Hospital, Ramadi, Anbar under the supervision of a dermatologist. The images were processed in Joint Photographic Expert Group (JPEG) format with color depth of 24 bits per pixel. For this work, a total of the images includes 200 psoriasis color images that amounted in a total of 100 abnormal and 100 normal cases with 200\*200 pixels. First row of Figure 1 shows the samples of healthy skin while the second row shows diseased skin samples.



Figure 1. Healthy skin (first row) and psoriasis lesions (second row) samples

### B. Methods

#### 1. The proposed framework

The goal of the paper is to diagnosis psoriasis lesions and compared the accuracy of the CAD psoriasis system by utilizing a diverse feature sets i.e., texture and color. Our CADP uses the machine learning paradigm in PCA-based ANN structure appeared in Figure 2. It can be expected to fill the need of making an apparatus for choosing the appropriate support in recognizable proof of first untimely psoriasis cases. This kind of choice support is a multi-disciplinary development merging therapeutic image handling techniques that require specialists', out how to improve the accuracy of psoriasis by distinguishing pieces of proof. In this way extraordinarily diminishing the false negative and positive affirm ages and upgrading the recognizable proof of genuine positives and true negative cases (affectability and specificity). From the system, texture and color features were extracted. The predominant feature set and a-priori physician classified labels (ground truth) are utilized as inputs to the framework classifier so as to decide the machine learning parameters. The dominant features produced in the framework were extracted from the test pictures. Subsequently, the machine learning in parameters from the framework and dominant features of test pictures were utilized to decide the class label of the test pictures.

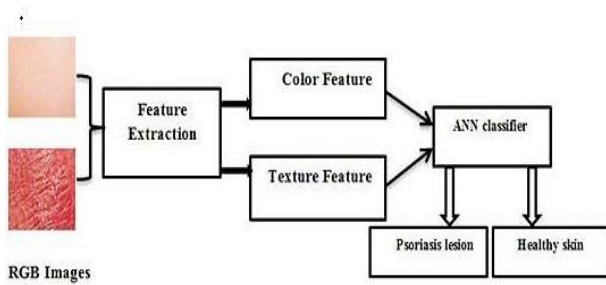

Figure 2. Proposed system for the psoriasis lesion diagnosis

1.1 RGB image (24-bit)

Colour images can be encoded by utilizing three 2-D matrices of the similar size, one for each color channel: red (R), green (G), and blue (B) each matrix element contains an 8-bit value, refers to the amount of red, green, or blue at that point in a [0, 255] scale. The collection of the three 8-bit values into a 24-bit number allows 224 (16,777,216, ordinarily determined to as 16 million or 16 M) color collections [21]. In this system used RGB psoriasis images without converting into grayscale because color image contains more information than density information, so it gave the system powerful diagnosis between classes.

1.2 Feature extraction

- Color histogram

Color histograms contain very useful information about color images. The color dissimilarity measure called histogram intersection, and its successors, have been widely used for object recognition and image retrieval [22]. The original method allows the presence of some occlusion and changes of viewpoint, but is sensitive to changes of illumination. The problems of illumination dependence can be partly decreased by preprocessing with color constancy algorithms or by extracting illumination invariant descriptors from the histograms. In applications in which the variations of illumination can be compensated, for example, in visual inspection the methods based on colour histograms have provided excellent results in problems like grading of randomly textured ceramic tiles and accurate colour measurements of coloured paper [23,24]. In fact, colour property extracted by histogram algorithm where computes frequency for red colour histogram. This property used to help in other dermatological issues such as skin cancer, melanoma, and tumor identification and treatment. Red colour histogram is good guided to discover about the psoriasis lesion. Red channel chosen because it is high contrast from other channels (green and blue channels). See Figure 3. Red band used to distinguish psoriasis lesion vs. normal skin.

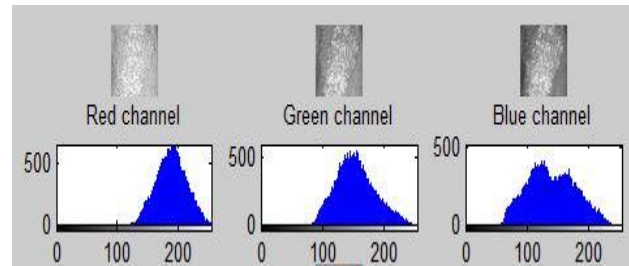

Figure 3. Shows a histogram for every channel and red channel has the highest frequency

-Texture features

Texture analysis has been an active area of research in pattern recognition. A variety of techniques have been used for measuring textural similarity and to highlight the edges that characterize the psoriasis lesion.

- Color Co-occurrence Matrix feature

Proposed Co-occurrence Matrix (CM) portrayal of texture features to mathematically represent the gray level spatial dependence of texture in an image. In this strategy the CM is built based on the orientation and distance also between picture pixels. Important statistics are extracted from this CM, as the portrayal of texture. Since fundamental texture patterns are represented by the periodic occurrence of certain gray levels, co-occurrence of gray levels at predefined relative positions can be a sensible measure of the nearness of texture and periodicity of the patterns. A number of texture features, for example, entropy, energy, contrast and homogeneity, can be extricated from the CM of gray levels of a picture. The gray level co-occurrence matrix  $C(i,j)$  is characterized by first indicating a displacement vector  $dxy = (\delta x, \delta y)$  and after that tallying all pairs of pixels isolated by displacement  $dxy$  and having gray levels  $i$  and  $j$ . The matrix  $C(i, j)$  is standardized by partitioning every element in the matrix by the aggregate number of pixel pairs. Utilizing this CM, he texture features metrics are registered as follows: Figure 4. A showcase for CM execution [25,26].

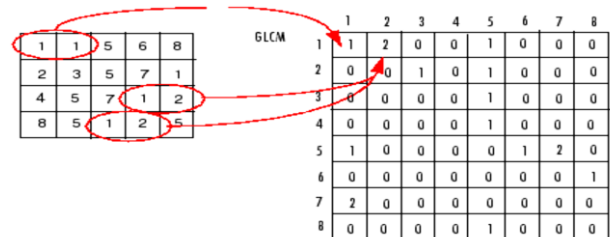

Figure 4. Show example for co-occurrence matrix implementation



In order to determine the spatial relationship of the spatial level values, a number of properties were calculated and most important [27].

$$\text{Energy} = \sum_i \sum_j Cij^2 \tag{1}$$

$$\text{Contrast} = \sum_i \sum_j (i - j)^2 Cij \tag{2}$$

$$\text{Entropy} = - \sum_i \sum_j Cij \log Cij \tag{3}$$

$$\text{Correlation} = \frac{\sum_i \sum_j (i,j) C(i,j) - \mu_x \mu_y}{\sigma_x \sigma_y} \tag{4}$$

$$\text{Homogeneity} = \sum_i \sum_j \frac{Cij}{1+|i-j|} \tag{5}$$

This method is shown in Figure 5. is an extension of the co-occurrence method to RGB images, i.e. images coded on n channels. In this case, let C1, C2,...Cu,...,Cn be the n channels of the image, each coded on m levels. Let t=(Δx, Δy) be a translation vector and (Cu→Cv) be a couple of channels. (Cu→Cv) indicates that in the couples of pixels defined by t, the first belongs to the channel Cu and the second to Cv. The generalized co-occurrence matrices are:

$$M_{t,(Cu \rightarrow Cv)}(i,j) = \# \{ (s, s+t) \in R^2 \mid C_u[s] = i, C_v[s+t] = j \} \tag{6}$$

With one matrix per couple of channels (Cu→Cv). In our thesis, t was a translation of 1 pixel in the eight directions and the matrices obtained were summed to obtain M(Cu→Cv). Let's quote that M<sub>t,(Cu→Cv)</sub>(i,j)=M<sub>t,(Cv→Cu)</sub>(j,i), so M(Cu→Cv) and M(Cv→Cu) are containing the same information. Both were summed to obtain a symmetric matrix M(Cu,Cv), and five Haralick features were computed on this matrix. In our case, color images are coded on three channels, leading to six different matrices: (R,R), (G,G), (B,B) that are the same as grey-scale co-occurrence matrices computed on one channel and (R,G), (R,B), (G,B) that take into account the correlations between the channels. So this method led to a total of 30 texture features.

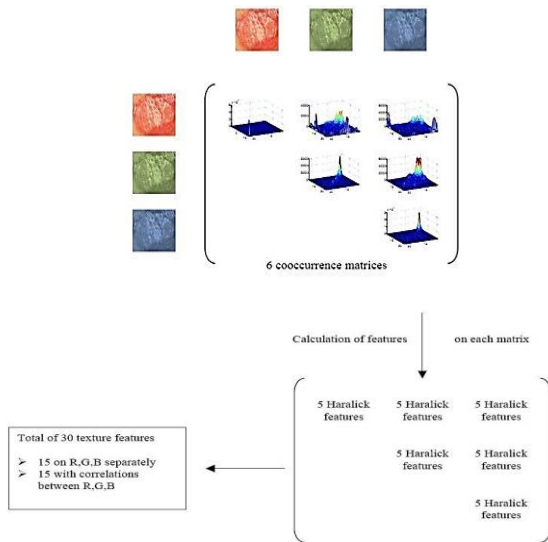

Figure 5. Illustration of the RGB image method applied psoriasis image

An algorithm for Texture feature extraction by using CCM method. Haralick extracted thirteen texture features from CM for an image; Algorithm 1. CCM features extraction shows below.

<p><b>Algorithm1: RGB-Color Co-Occurrence Matrix</b></p> <p><i>Input: Color images for psoriasis lesion and healthy skin.</i></p> <p><i>Output: Texture feature vector.</i></p> <p><i>Goal: Texture feature extraction.</i></p> <p><b>Step1:</b> Reading RGB-color image.</p> <p><b>Step2:</b> Dividing an image into three bands, the CM is executed on each color band separately. In addition, each pair of the color bands.</p> <p><b>Step3:</b> In CCM we are going to extract the feature from R band, G band and B band, R band with G band, R band with B band and G band with B band.</p> <p><b>Step4:</b> Finding the Energy of six channels for calculating the Energy follow this formula.</p> $E = \sum_i \sum_j Cij^2.$ <p><b>Step5:</b> Finding the Contrast of six channels for calculating the Contrast follow this formula.</p> $I = \sum_i \sum_j (i - j)^2 Cij.$ <p><b>Step6:</b> Finding the Entropy of six channels for calculating the Entropy follow this formula.</p> $S = - \sum_i \sum_j Cij \log Cij.$ <p><b>Step7:</b> Finding the correlation of six channels for calculating the correlation follow this formula.</p> $COR = \frac{\sum_i \sum_j (i,j) C(i,j) - \mu_x \mu_y}{\sigma_x \sigma_y}$ <p><b>Step8:</b> Finding the Homogeneity of six channels for calculating the Homogeneity follow this formula.</p> $H = \sum_i \sum_j \frac{Cij}{1+ i-j }$ <p><b>Step9:</b> Output of CCM algorithm is 30 texture features. 15 on R,G,B separately, 15 with correlations between R,G,B.</p> <p><b>Step10:</b> The result of this algorithm is a vector with 30 values.</p>
---

- Local Binary Pattern features

The Local Binary Pattern (LBP) administrator was proposed by Ojala et al. [28], to depict the picture texture. LBP administrator is a computationally very effective yet intense feature for analyzing texture structures [29]. It works by contrasting the gray value of the central pixel with its encompassing 8 pixels (for a given size of 3 x 3 pixel neighborhood for every central pixel) a binary value can be gotten [30]. So the LBP administrator can be viewed as a requested arrangement of binary comparisons between the gray values of the centroid pixels and their encompassing pixels and what number of correlations are there relying upon the number

of pixels in the chosen neighborhood. The binary value will be changed over to the decimal value to get the LBP value. The output value of the LBP administrator can be characterized as follows [30]:

$$LBP(xc, yc) = \sum_{i=0}^7 2^i S(g_i - gc) \quad (7)$$

Where  $gc$  corresponds to the gray value of the centroid pixel,  $(xc, yc)$  are its coordinates,  $g_i$  ( $i = 0, 1, 2, \dots, 7$ ) is the gray values of its encompassing 8 pixels and  $S(g_i - gc)$  can be characterized as follows:

$$S(g_i - gc) = \begin{cases} 1, & g_i \geq gc \\ 0, & \text{otherwise} \end{cases} \quad (8)$$

See Figure 6 for an example of a fundamental LBP administrator and how to compute the LBP value.

The LBP administrator was extended to utilize neighborhoods of various sizes to have the capacity to deal with large scale structures that might be the representative features of a few types of textures [31,32]. The notation is the following the  $(P, R)$  will be utilized as a sign of neighborhood arrangements.  $P$  indicates to the number of pixels in the neighborhood and  $R$  indicates to the radius of the neighborhood. The neighborhood can be either in a circular or square form. See Figure 7 for an example of a circular neighborhood for a similar neighbor set of pixels, however with various values of the radius. LBP administrator can likewise be reached out to other different definitions and patterns. A standout amongst the most vital and effective expansions to the essential LBP administrator is called uniform LBP (ULBP).

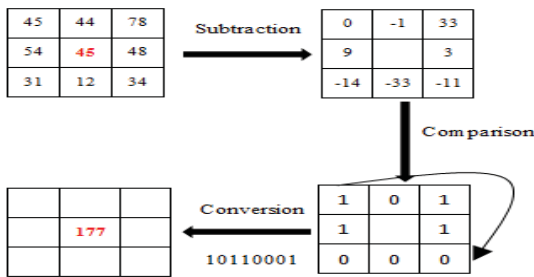

Figure 6. The basic LBP operator [31,32]

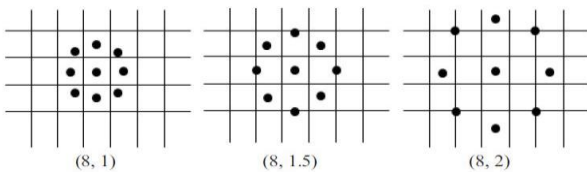

Figure 7. Three different neighborhoods [31]

LBP is called uniform if the binary pattern contains at most two distinct changes from 0 to 1 or 1 to 0 when the binary string is seen as a circular bit string [31]. For instance, 11000011, 00111110 and 10000011 are uniform patterns. Countless of statistics have been extricated from the pictures and the findings showed that most portion of patterns in pictures are uniform patterns. Ojala announced that with  $(8, 1)$  neighborhood, uniform patterns represent somewhat less than 90% of all patterns and with  $(16, 2)$  neighborhood, uniform patterns represent about 70% of all patterns [31]. The LBP is utilized to label a picture and the histogram of the labeled picture can be characterized as follows [32]:

$$H_i = \sum_{x,y} I(f(x,y) = i), i = 0, 1, \dots, n - 1 \quad (9)$$

Where "n" is the number of various labels delivered by the LBP administrator,  $f(x, y)$  is the labeled picture and  $I(A)$  is a decision function with value 1 if the occasion is valid and 0 false. To shape the LBP histogram, the picture must be isolated into 9 sub-regions. Then, computes the LBP histogram for each sub-region [33]. Lastly, the nine sub-region histograms must be consolidated to frame the feature histogram of the picture. One sub-region of the LBP histogram contains the local feature of that sub-region and consolidating the LBP histograms for all sub-regions represent the global properties for the entire picture [33]. The LBP administrator has been effectively applied for some applications, for example, texture classification [34,35,36], texture segmentation [37], face recognition [38], and facial expression recognition [39].

In order to introduce color information into the original LBP administrator, and in addition to expanding its photometric invariance properties of dealing with various types of illumination changes. We proposed, in this paper, RGB-LBP This administrator is gotten by computing LBP over each of the three bands of the RGB color space independently, and after that connecting the findings together. It is invariant to monotonic light power change because of the property of the first LBP, and has no extra invariance properties. Since color plays a critical part for refinement between objects, and to increase its photometric invariance properties of managing various types of brightening changes color LBP administrators are proposed. So every approximation picture is isolated into  $3 \times 3$  blocks (sub-regions). Next we get the statistic histogram for each sub-region and afterward connect every one of the histograms together to acquire a vast histogram arrangement as psoriasis lesion features for classification. See Figure 8. After extracting texture features from RGB-LBP algorithm entered into NN to classify psoriasis lesion vs. normal skin. Among the advantages of LBP are its computational straightforwardness. For texture depiction, histograms of



LBP patterns are utilized. The opponent color space is constructed to be consistent with human visual system, because it is proven more efficient for human visual system to record differences between the responses of cones, rather than each type of cone's individual response.

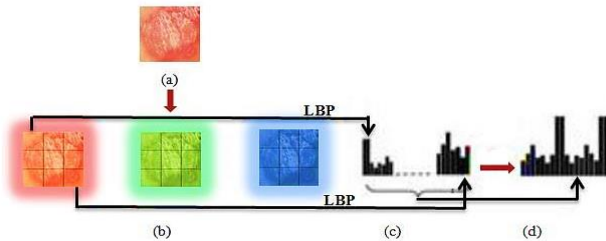

Figure 8. Psoriasis description with LBP. (a) Psoriasis RGB image. (b) 3-channel image is divided into 3\*3 blocks. (c) LBP histogram from each block. (d) Feature histogram

We use RGB-LBP administrators keeping in mind the end goal to increment optometric invariance property and discriminative energy of the first LBP administrator or as opposed to utilizing gray scale level. The LBP administrator is a standout amongst other performing texture descriptors and it has been widely utilized as a part of different applications. In addition, each pair of color panels. The findings texture descriptor is six times longer than the gray scale variant, which may make it unusable in a few applications, however features extricated from psoriasis pictures were very encouraging. The random appropriation of pixels of psoriatic lesions and nonlinear behavior among the recurrence components, innovates us to utilize LBP texture features; Algorithm 2 for RGB-Local Binary Pattern feature extraction is shown below.

#### Algorithm 2: RGB-Local Binary Pattern

*Input:* Color images for psoriasis lesion and healthy skin after detecting the lesion.

*Output:* Texture feature vector.

*Goal:* Texture feature extraction.

**Step1:** Reading color image.

**Step2:** Dividing an image into three channels, the LBP administrator is implemented on each color band independently. Moreover, each pair of the color band is utilized in collecting opponent color patterns so that the centroid pixel for a neighborhood and the neighborhood itself are taken from various color bands.

**Step3:** Each channel compares the center pixel to each of the 8 neighboring pixels. Follow the pixels along the circle with rotation  $45^\circ$ .

**Step4:** To achieve rotation invariance with LBP

$$LBP_{P,R}^i = \min\{ROR(LBP_{P,R}, i) | i=0, \dots, P-1\}$$

**Step5:** Calculating LBP the follow this formula:

$$LBP_{P,R} = \sum_{p=0}^{P-1} s(gp - gc)2^p, S(x) = \begin{cases} 1, x \geq 0 \\ 0, x < 0 \end{cases}$$

**Step6:** After the LBP pattern of every pixel is recognized, a histogram is created to represent the texture picture.

$$H(k) = \sum_{i=1}^I \sum_{j=1}^J f(LBPP, R(i, j), k), k \in$$

$$[0, K], f(x, y) = \begin{cases} 1, x = y \\ 0, \text{otherwise} \end{cases}$$

$LBP_{8,1}^i = 36$  feature histogram from one channel.

**Step7:** Normalize histograms:

$$Ni = \frac{Hi}{\sum_{j=0}^{n-1} Hj}$$

$LBP_{8,1}^i = 36$  local features histogram for one band.

**Step8:** Saving properties from six channels.

**Step9:** The result of this algorithm is a vector with 216 values.

Where gp is the value of the neighboring pixel, gc is the value of the central pixel, and P is the total number of neighboring pixels, P is the total number of involved neighbors, and R is the radius of the neighborhood. Where K is the maximal LBP pattern value. Where ROR(x,i) represents a circular bit-wise right shift function on the binary format vector x for i times and  $LBP_{P,R}$  represents the P-bit LBP pattern.

### 1.3 Classification based on ANN

Classification is a critical stage in distinguishing psoriasis lesions vs. normal skin or psoriasis lesions vs. other skin diseases. In classification classifier is utilized for object recognition and classification. The classifiers recognize the object and classify based on the extricated features of a picture given as an input. There are two important stages in the classification. They are training and testing stage. In the training stage, the pre-decided information and its related class labels are utilized for classification.

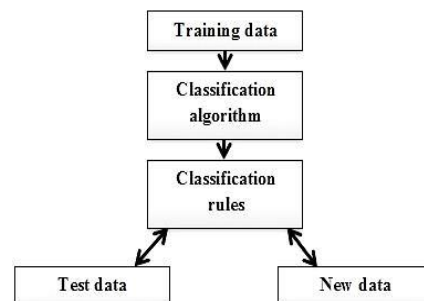

Figure 9. Different stages in classifier

The distinctive stages in classifier are appearing in Figure 9. The distinctive stages are training and testing [40]. In this paper utilized the Neural Network for classification of psoriasis lesions pictures with different features.

Neural network comprises of various of very simple and very interconnected processors, additionally called neurons, which are like the biological neurons in the human's cerebrum. The neurons are associated by weight joins which pass signals starting with one neuron then onto the next. Every neuron receives various of input motions through its connections; however, the neurons deliver just a single output signal. The output signal is transmitted through the neuron's outgoing association (corresponding to the biological axon). The outgoing association, thus, separated into various branches that transmit a similar signal (the signal is not partitioned among these branches in any way). The outgoing branches end at the incoming connections of different neurons in the network [41]. The target of the step is to recognize psoriasis lesions and normal skin, subsequent to getting features vector and keeping them, the diagnosis step takes follows. In our work, a neural network is utilized for recognizing psoriasis lesions and healthy skin, the performance of neural network depends on the network architecture. In dermatology, correct diagnosis of skin lesion needs a preparatory analysis of its texture and color. The fundamental objective of this digital image analysis is to give the quantitative data. Characteristics a similitude between all psoriasis lesions types, for example, color and texture of the lesions is helpful features for dermatologist. In our work, a neural network is utilized for distinguishing between psoriasis lesions vs. healthy skin, the performance of neural network depends on the network architecture.

*- The structure of the neural network*

We utilized a feed-forward backpropagation Neural Network (NN) with adaptive learning rate. The performance of neural network relies on the network architecture. The NN have 3 layers; an input layer (N neurons), a hidden layer (N neurons) and the output layer (2 neurons). The activation function utilized is the tan sigmoid function, for both the hidden and the output layer. The input to the neural network is the feature vector containing N part of each features, the NN has just two outputs as appeared.

Figure 10. Shows the classification with ANN in our system where the vector feature for every feature extracted entered as input into ANN separately then calculated average of all classifications.

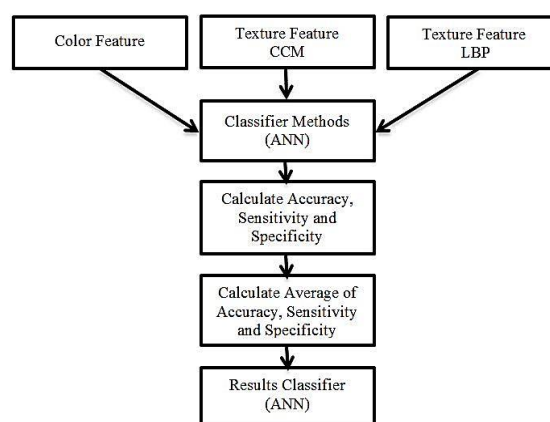

Figure 10. Classifier method

**4. EXPERIMENT RESULTS**

The classification based on NN into normal vs. abnormal depending on color and texture feature extraction of psoriasis image, so used a feed-forward backpropagation Neural Network (NN) with adaptive learning rate. The NN have 3 layers; an input layer (256 neurons for color feature and 30 neurons for texture feature with CCM and 216 neurons for texture feature with LBP), a hidden layer (60 and 80 neurons based on input features) and the output layer (2 neurons). The activation function used is the tan sigmoid function, for both the hidden and the output layer. The input to the neural network is the feature vector containing 256 features component of red (R) channel only on RGB color space, The input to the neural network is the feature vector containing 30 color-texture features with CCM and the input to the neural network is the feature vector containing 216 color-texture features 216 with LBP, the NN has only two outputs as shown in Figure 11.

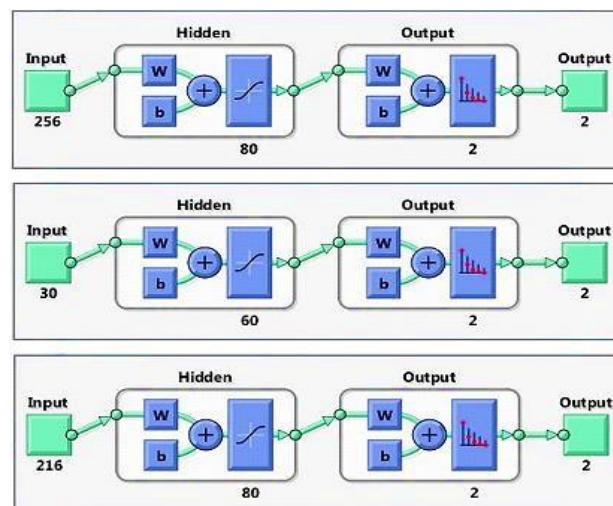

Figure 11. The neural network structures for classifying all features separately



## 5. PERFORMANCE EVALUATION MEASURES

When classification is done results may have an error rate, whether to fail to identify a psoriasis lesion vs. a normal skin. The performance measure to the diagnosis psoriasis lesions is done by the expressions of true and false positive, true and false negative, sensitivity, specificity respectively and the other measures. See Table 1.

TABLE 1. SHOW OVERALL THE ASSESSMENT OF PERFORMANCE FOR DIAGNOSIS PSORIASIS LESION

	COLOR Classification	TEXTURE CCM Classification	TEXTURE LBP Classification	Average system decision	Feature Fusion Voting
Sensitivity	100%	100%	100%	100%	100%
Specificity	96.7%	100%	100%	98.9%	100%
PPV	96.6%	100%	100%	98.8%	100%
NPV	100%	100%	100%	100%	100%
Accuracy	99.5%	100%	100%	99.8%	100%

The system passed all the significant ensuring all classification parameters such as sensitivity, specificity and accuracy for all feature set. Further, it shows the dominant strong behavior of texture features. Overall, this research shows encouraging results and confirms the ability to develop a CADx system for diagnosis of psoriasis and its clinical translation.

## 6. DISCUSSION RESULTS

The analysis of the results Table 1 shows that the best percentages of good classification are achieved with the CCM and LBP methods, the images diagnosis of psoriasis lesions with 100% accuracy. Behind, the fusion voting of texture and color features reaches 100% improve of accuracy average model. The CCM and LBP methods proposed gives very good results for a classification problem. The use of the co-occurrence matrix method computed both within and between the color bands allows to achieve such results, so this way to study color-texture seems to be a promising one. Moreover, the computation time for this method is not prohibitive and allows real time applications. Furthermore, experiments using only the features computed within color bands and correlations between bands show that are complementary. Actually, the results with correlations achieve 100%. This result shows that correlations between the color bands introduce new and relevant information and so is worth being used as a color-texture descriptor in addition with features computed within color bands.

## 7. CONCLUSION

The diagnosis of skin lesion has been a long time and tedious process. The conventional diagnostic test is agonizing to patients. So, we have created computer aided diagnosis system CADx helped psoriasis lesion using ANN, which gives preferable accuracy and quicker analysis over the human physician. The colors and color-texture feature plays important role in diagnosing particular disease. Presented the paper a similar investigation of the performance of computer-aided diagnosis system for psoriasis lesions picture classification utilizing a number of the feature sets i.e. texture and color. in the present time, CADx framework became a tool an for doctors and therefore it is imperative to have precise and dependable CADx framework. Our CAD framework passed all the significant dataset conventions to guarantee all classification parameters, for example, accuracy, sensitivity and specificity for each the three feature sets. Further, it demonstrates the overwhelming conduct of higher LBP. Generally speaking, this study indicates encouraging results and affirms the capacity to develop a CADx framework for diagnosis of psoriasis lesions and its clinical interpretation.

## REFERENCES

- [1] Lu, J. (2014). *Objective assessment of psoriasis treatment through skin images* (Doctoral dissertation, University of Melbourne, Department of Computing and Information Systems).
- [2] Taur, J. S., Tao, C. W., Chen, C. C., & Yang, C. W. SEGMENTATION OF PSORIASIS VULGARIS IMAGES USING ORTHOGONAL SUBSPACE TECHNIQUES.
- [3] Lu, J., Kazmierczak, E., Manton, J. H., & Sinclair, R. (2013). Automatic segmentation of scaling in 2-d psoriasis skin images. *IEEE transactions on medical imaging*, 32(4), 719-730.
- [4] Shrivastava, V. K., Londhe, N. D., Sonawane, R. S., & Suri, J. S. (2015). First review on psoriasis severity risk stratification: An engineering perspective. *Computers in biology and medicine*, 63, 52-63.
- [5] Taur, J. S. (2003). Neuro-fuzzy approach to the segmentation of psoriasis images. *The Journal of VLSI Signal Processing*, 35(1), 19-27.
- [6] Vij, S., Sharma, S., & Marwaha, C. (2013, July). Performance evaluation of color image segmentation using K means clustering and watershed technique. In *Computing, Communications and Networking Technologies (ICCCNT), 2013 Fourth International Conference on* (pp. 1-4). IEEE.
- [7] Mohammed, M. A., Ghani, M. K. A., Hamed, R. I., Abdullah, M. K., & Ibrahim, D. A. (2017). Automatic segmentation and automatic seed point selection of nasopharyngeal carcinoma from microscopy images using region growing based approach. *Journal of Computational Science*, 20, 61-69.
- [8] Shrivastava, V. K., Londhe, N. D., Sonawane, R. S., & Suri, J. S. (2015). Reliable and accurate psoriasis disease classification in dermatology images using comprehensive feature space in machine learning paradigm. *Expert Systems with Applications*, 42(15), 6184-6195.





- [9] Jones, M. J., & Rehg, J. M. (2002). Statistical color models with application to skin detection. *International Journal of Computer Vision*, 46(1), 81-96.
- [10] Al Abbadi, N. K., Dahir, N. S., Al-dhalimi, M. A., & Restom, H. (2010). Psoriasis Detection Using Skin Color and Texture Features 1.
- [11] Miss.Priyanka s. Biradar, 2Mr.S.N.Patil. (2015). PSORIASIS DETECTION USING COLOR AND TEXTURE FEATURE. INTERNATIONAL JOURNAL OF ADVANCED COMPUTING AND ELECTRONICS TECHNOLOGY (IJACET), ISSN (PRINT):2394-3408,(ONLINE): 2394-3416,VOLUME-2, ISSUE-4.
- [12] Shrivastava, V. K., Londhe, N. D., Sonawane, R. S., & Suri, J. S. (2016). Computer-aided diagnosis of psoriasis skin images with HOS, texture and color features: a first comparative study of its kind. *Computer methods and programs in biomedicine*, 126, 98-109.
- [13] Ze-Nian, L., & Drew, M. S. (2004). Fundamentals of multimedia. *School of computing science Simon Fraser University. Sweden, Suecia: Pearson Prentice Hall*.
- [14] Swain, M. J., & Ballard, D. H. (1991). Color indexing. *International journal of computer vision*, 7(1), 11-32.
- [15] Boukouvalas, C., Kittler, J., Marik, R., & Petrou, M. (1999). Color grading of randomly textured ceramic tiles using color histograms. *IEEE Transactions on Industrial Electronics*, 46(1), 219-226.
- [16] Pietikainen, M., Nieminen, S., Marszalec, E., & Ojala, T. (1996, August). Accurate color discrimination with classification based on feature distributions. In *Pattern Recognition, 1996., Proceedings of the 13th International Conference on* (Vol. 3, pp. 833-838). IEEE.
- [17] Kurani, A. S., Xu, D. H., Furst, J., & Raicu, D. S. (2004, August). Co-occurrence matrices for volumetric data. In *7th IASTED International Conference on Computer Graphics and Imaging, Kauai, USA* (pp. 447-452).
- [18] Lee, K., Jeon, S. H., & Kwon, B. D. (2004). Urban feature characterization using high-resolution satellite imagery: Texture analysis approach. In *Map Asia Conference*.
- [19] Arvis, V., Debain, C., Berducat, M., & Benassi, A. (2011). Generalization of the cooccurrence matrix for colour images: application to colour texture classification. *Image Analysis & Stereology*, 23(1), 63-72.
- [20] Ojala, T., Pietikäinen, M., & Harwood, D. (1996). A comparative study of texture measures with classification based on featured distributions. *Pattern recognition*, 29(1), 51-59.
- [21] Zhu, C., Bichot, C. E., & Chen, L. (2010, August). Multi-scale color local binary patterns for visual object classes recognition. In *Pattern Recognition (ICPR), 2010 20th International Conference on* (pp. 3065-3068). IEEE.
- [22] Meng, J., Gao, Y., Wang, X., Lin, T., & Zhang, J. (2010, August). Face recognition based on local binary patterns with threshold. In *Granular Computing (GrC), 2010 IEEE International Conference on* (pp. 352-356). IEEE.
- [23] Ahonen, T., Hadid, A., & Pietikainen, M. (2006). Face description with local binary patterns: Application to face recognition. *IEEE. transactions on pattern analysis and machine intelligence*, 28(12), 2037-2041.
- [24] Wang, W., Chang, F., Zhao, J., & Chen, Z. (2010, July). Automatic facial expression recognition using local binary pattern. In *Intelligent Control and Automation (WCICA), 2010 8th World Congress on* (pp. 6375-6378). IEEE.
- [25] Liu, X., Du, M., & Jin, L. (2010, July). Face features extraction based on multi-scale LBP. In *Signal Processing Systems (ICSPS), 2010 2nd International Conference on* (Vol. 2, pp. V2-438). IEEE.
- [26] Ojala, T., Pietikainen, M., & Maenpaa, T. (2002). Multiresolution gray-scale and rotation invariant texture classification with local binary patterns. *IEEE Transactions on pattern analysis and machine intelligence*, 24(7), 971-987.
- [27] Topi, M., Timo, O., Matti, P., & Maricor, S. (2000). Robust texture classification by subsets of local binary patterns. In *Pattern Recognition, 2000. Proceedings. 15th International Conference on* (Vol. 3, pp. 935-938). IEEE.
- [28] Topi, M., Matti, P., & Timo, O. (2000). Texture classification by multi-predicate local binary pattern operators. In *Pattern Recognition, 2000. Proceedings. 15th International Conference on* (Vol. 3, pp. 939-942). IEEE.
- [29] Ojala, T., & Pietikäinen, M. (1999). Unsupervised texture segmentation using feature distributions. *Pattern Recognition*, 32(3), 477-486.
- [30] Ahonen, T., Hadid, A., & Pietikainen, M. (2006). Face description with local binary patterns: Application to face recognition. *IEEE transactions on pattern analysis and machine intelligence*, 28(12), 2037-2041.
- [31] Shan, C., Gong, S., & McOwan, P. W. (2005, September). Robust facial expression recognition using local binary patterns. In *Image Processing, 2005. ICIP 2005. IEEE International Conference on* (Vol. 2, pp. II-370). IEEE.
- [32] Kavimathi, P. (2016). Comparative Analyses of Classifiers for Diagnosis of Skin Cancer using Dermoscopic Images. *Indian Journal of Science and Technology*, 9(43).
- [33] Michael, N. (2005). Artificial intelligence a guide to intelligent systems.



**Ms. Tanya Shakir** Jarad received her B.Sc. in Computer Science and Information Technology from College of Computer, University of Anbar, Iraq in 2013. Her current research interests include Artificial Intelligence, Biomedical Computing and medical image processing .



**Ali Jbaeer** Dawood has received Ph. D. in Computer science, Iraqi Commission for Computers and Informatics – Informatics Institute for Postgraduate Studies (2010). He joined in (2000-2003) to Computer Science Department College of Science- Baghdad University, Baghdad, Iraq as an external lecturer. He joined in (2001-2003) to Computer Science Department College of Computer, Anbar University, Anbar, Iraq as an external lecturer. He joined in (2002-2007) to Computer Science Department, AL-Mansour University College, Baghdad, Iraq as an external lecturer. He joined in (2005-2007) to Computer Science Department, College of Science