



USoil: Development of USCS-Based Soil Classifier Using Digital Image Processing and Convolutional Neural Network

Gilfred Allen M. Madrigal^{1,2}, Adrian L. Beltran¹, Sean Paul Andrei F. Diaz¹, Roel Ryan F. Galos¹, Jeffrey Karl H. Roca¹ and Camille Ann V. Santos¹

¹Department of Electronics Engineering, Technological University of the Philippines, Manila, Philippines

²Center for Engineering Design, Fabrication, and Innovation, College of Engineering, Technological University of the Philippines, Manila, Philippines

Received 27 May 2021, Revised 9 Mar. 2022, Accepted 15 Jun. 2022, Published 1 Jul. 2022

Abstract: The purpose of this study is to demonstrate how image processing and convolutional neural networks may be utilized to efficiently classify a soil sample using the Unified Soil Classification System (USCS). The system is composed of five sections: jar testing, picture capture, image processing, Convolutional Neural Network (CNN) training system, and outcome. The convolutional neural network is a type of machine learning that enables quicker image processing while still providing accurate evaluation and output. The system will be based on picture data collected from soil samples using the camera included in the hardware component. As the default neural network tool through Google Colab, the breakdown will be 70% for training, 15% for testing, and another 15% for validation. The application will then display the projected amount and proportion of each soil type – silt, sand, gravel, and clay – in a given sample, before categorizing it according to the conditions specified for each classification. In all, this study classified soils and was found to be 92.4% accurate.

Keywords: Convolutional Neural Network, Google Colab, Image Processing, Soil Classification, Unified Soil Classification System

1. INTRODUCTION

Soil type is crucial in the determination of the foundation types in construction and in agriculture. Soil present in the surveyed land is needed to be analyzed whether it is strong or weak in supporting foundations of houses and buildings, or else a building developed may not last through potential natural disasters. And if soil strength was not identified, serious environmental hazards will be more perilous. In order to measure soil quality, Soil Testing should be performed [1]. Soil identification methods at present are time consuming, mostly inaccurate or very costly. As a result, the proponents have developed a machine learning comparison for soil categorization that will aid in the adoption of a system specifically designed for soil evaluation.

There are different ways to classify soil types. Consequently, there are different soil classification standards e.g., AASHTO, USDA, and USCS. The American Association of State Highway and Transportation Officials or AASHTO standards are mostly applied only on public highways and transportation purposes. United States Department of Agriculture is the simpler type of soil classification method compared to the Unified Soil Classification System or USCS

and AASHTO. However, USCS offers more complexity on classifying strength of soil. USCS focuses much more on constructing buildings and land development [2].

Multiple algorithms have been used in analyzing soil types conducted by Harlianto, Adji, & Setiawan. Their team simulated several algorithms like SVM, CNN, naïve bayes and decision tree using 10 data sets of soils. Their study [3] concluded that SVM, utilizing the linear function kernel surpassed the other algorithms with 82.35% accuracy.

In a study in 2014 [4], a team of researchers used digital image processing technique using pixel map alongside a theory called “Cellular Automata” which assisted in the identification of the soil rock mixtures. A photo of the sample is taken and then converted it into a grayscale and then, the image is imported into the CAD for its cellular automata transform and continuous numerical model.

In 2018, a research [5] was conducted regarding four different soil-rock mixtures with different rock rates of 0, 15%, 35%, and 45%, as well as soil-rock mixtures containing different peak load of compression failures. Then, the researchers used image processing in order to identify



the cracks found on the soil rock mixtures and to determine whether the cracks are in a normal to serious rate of damage. The researchers concluded that the existence of rocks in soil contents prevented highly cracked soil-rock mixtures and its expansion, and that image processing of soil-rock mixtures will greatly help in determining the geometric stability of the environment. A similar study in 2014 [6] was conducted in order to classify the rock types by its color space using neural networks captured through images. The rock was classified into four types according to its shape, size, and color space. The researchers utilized machine learning using 1000 images divided into its training, testing, and verification. They also tested with a random image sample of rocks to increase the accuracy of the neural network data. The experiment resulted in a total of 95% accuracy on the rock classification method done.

In another study [7], a research was conducted that predicts the soil type that is suitable in planting certain crops. The algorithm used are weighed k-Nearest Neighbor (k-NN), Bagged Trees, and Gaussian kernel-based SVM. Another study [8] was conducted to analyze soil data sets through data mining techniques. This research is a comparative study that focuses on soil classification using several algorithms available through the data mining tool WEKA such as Naïve Bayes, J48 of the C4.5 algorithm, and JRip.

Several machine learning algorithms intended for soil classification using real soil data sets as well as to attempt were tested to create a system in which soils and rocks are applied into machine learning and classified according to their types, particle size, grading and viability for construction projects and applications. The algorithm involved is Faster R-CNN.

Great image quality is needed for better accuracy and result of an image sample. A study [9] conducted in 2017 in order to assess the quality of soil and soil nutrients. In order to gather quality image samples, the researchers decided to develop a box in order to avoid interference from light and shadows during photo capturing phase. And so, the researchers came up with the dimensions for the controlled light box based on the size of their test tubes and the desired lighting the test tubes needed.

Another important parameter for a neural network is its inference time. Inference time is the time it takes for a neural network to analyze a sample in a real-time scenario. A test [10] was conducted in order to measure the efficiency of each type of R-CNN. The fastest inference time recorded was the Faster R-CNN, a successor of R-CNN, for about 0.2 seconds. Aside from being the fastest, it can also be applied on to real-time analysis.

The hydrometer and pipette methods are often used for soil testing and categorization. Both procedures rely significantly on human engagement and time, which can result in errors and incorrect findings. Inaccurate findings might

have dire repercussions if the incorrect sort of foundation is utilized. Incorrect foundation types can result in structures shifting, cracking, and becoming unstable. More precise findings can be obtained by employing X-ray attenuation or laser diffraction techniques, although these techniques need highly specialized and hence expensive equipment.

The general objective of this study is to develop a USCS-based soil classifier using digital image processing and convolutional neural network. Specifically, the proponents aim to:

- (1) Design an illuminated box which will be used for capturing soil sample images.
- (2) Develop an image processing system and convolutional neural network for differentiating soil samples.
- (3) Develop a graphical user interface with necessary features to access the data from the image processing system and;
- (4) Undergo in reliability and accuracy validation of the system.

With those aforementioned above, the USCS standards were implemented including the Main and Sub Classifications using CNN for the soil classification. The system will undergo training for identifying the differences of soil samples using its characteristics, whether large or small particles, or light or dark saturation. The research will also focus on using inorganic soils due to nature of soils in land development.

This study aims to help determine strong foundations that will translate into successful development of buildings that can be durable for a long period of time. Also, this study aims to be considered as a cost-efficient way of analyzing soil-rock mixtures, an alternative for the mainstream ways of costly laboratory tests. It will also help the environment since classic soil analyzing techniques tend to hamper the site in which soil samples are gathered. Consequently, this study mainly focuses on the development of USCS-based soil classifier using digital image processing and convolutional neural network, in which it utilizes soil samples for data collection, processing and learning. It concentrates on determining soil classification especially its strength for infrastructure foundation purposes. Lastly, a system was developed in this paper in which soils and rocks are applied into machine learning and classified according to their types, particle size, grading and viability for construction projects and applications.

2. METHODOLOGY

The methodology discusses important details about the system. Convolutional Neural Network is the focal part of the system. In Figure 1, the system's process flowchart is presented. Convolutional Neural Network is used for training of the input data and HD Camera for gathering of the data images. To measure the grading of soil, it is obtained through the different stages of the system: Soil Sample Gathering, Data Recording through Digital Image, Image Processing, and Convolutional Neural Network. Soil Sample Gathering served as the input data to be captured

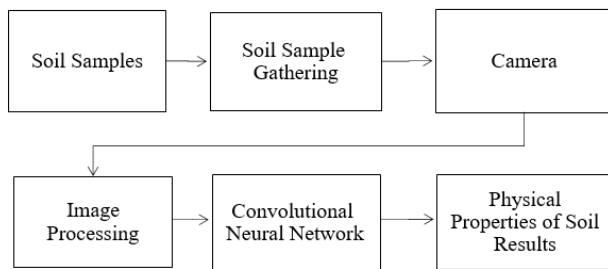

Figure 1. Process flowchart of USoil

using the camera for data training of the Convolutional Neural Network to make more accurate results. Image Processing is the system of converting the gathered data into image using different image processing techniques. The determination of soil strength for infrastructure development using digital image processing and convolutional neural network that results to physical properties and specification of soil is completed through the following sections – Soil Samples Gathering, Digital Image Recording, Digital Image Processing, Data Training and Efficiency Testing.

A. Soil Classification System

In geotechnical engineering, one of the systems of texture classification of soil used by engineers is the Unified Soil Classification System (USCS). USCS is widely used by geotechnical engineers for measuring the particle size distribution, soil plasticity, liquid limit, and organic matter concentrations needed to know the soil strength. USCS is divided into two categories, the fine-grained soil and the coarse-grained soil. Fine-grained soil is gravels (G) and sands (S) that has <50% passing through #200 sieve. Coarse-grained soil are silts (M) and clays (C) that has $\geq 50\%$ passing through #200 sieve [2].

According to USCS, the results after surveying the soil will be composed of two letters which stands for the following:

Primary Labels: G for Gravel, S for Sand, M for Silt, C for Clay, and O for Organic.

Secondary Labels (Coarse Grained): M for Silty, C for Clayey, P for Poorly Graded (sizes of grain are relative), and W for Well Graded (varying sizes of grain).

B. The Jar Testing

The main composition of loam normally consists of clay, sand, and silt particles. But gravel occasionally comes into consideration from time to time. These four compositions are common when acquiring samples from surveyed construction sites. Most of the time, these four soil types do not particularly become equal all the time and typically are not equal in distribution. From the statement before, the Jar Test helps in determining the soil percentage within a soil sample [11]. The Jar Test will help in knowing the

percentage of the soil sample. In completing the Jar Test, these procedures should be followed:

1) Acquiring the materials. The materials needed for the jar test are:

- a) Mason Jar. These jars are transparent that has a lid with a tight seal, creating a container without outside obstruction. Figure 2 represents the mason jar.
- b) Dishwashing Liquid. The brand of the dishwashing liquid does not matter but the amount of liquid mixed in with the soil. It is highly recommended to use a dishwashing liquid that does not easily foam.
- c) Clean Water. A clean source of water should be acquired in order for the soil to settle within the jar perfectly.

2) The Procedure

- a) Add about 2/3 amount of clean water into the jar.
- b) Add about a tablespoon of dishwashing liquid after the water has been placed.
- c) The soil sample comes next. Make sure that the soil sample does not have large organic materials mixed in with the sample (e.g., twigs, rocks, etc.).
- d) Leave some space inside the jar for the shaking process.
- e) Close the lid tightly and shake the jar for about three minutes.
- f) Lastly, let the mixture settle for at least 24 hours. Place it in an undisturbed place and prepare for the soil sample image acquisition.

Figure 3 shows the after-process of the Jar Testing before the soil rearranges itself. Figure 4 shows the after-process of the Jar Testing after the soil settles. The layers can be seen clearly. This soil sample consists mostly of gravel and sand, with some clay. In a normal occurrence, sand will settle at the bottom since sand becomes heavier when mixed with water, silt and clay at the bottom, and gravel at the top due to its bigger texture and grain size.

C. Gathering of Soil Sample Sets

The authors gathered 30 training sets and 10 test sets in different locations in the Philippines such as Las Piñas City, Parañaque City, Manila, and Bacoor City for the data needed for this project to be successful. These will serve as the repetitive data sets in different surface areas of soil for more accurate results. Some of the data sets are shown in Figure 5.

D. Hardware Development

To achieve the complete hardware development, necessary things are needed to acquire. Figure 6 is the target



Figure 2. The Mason Jar

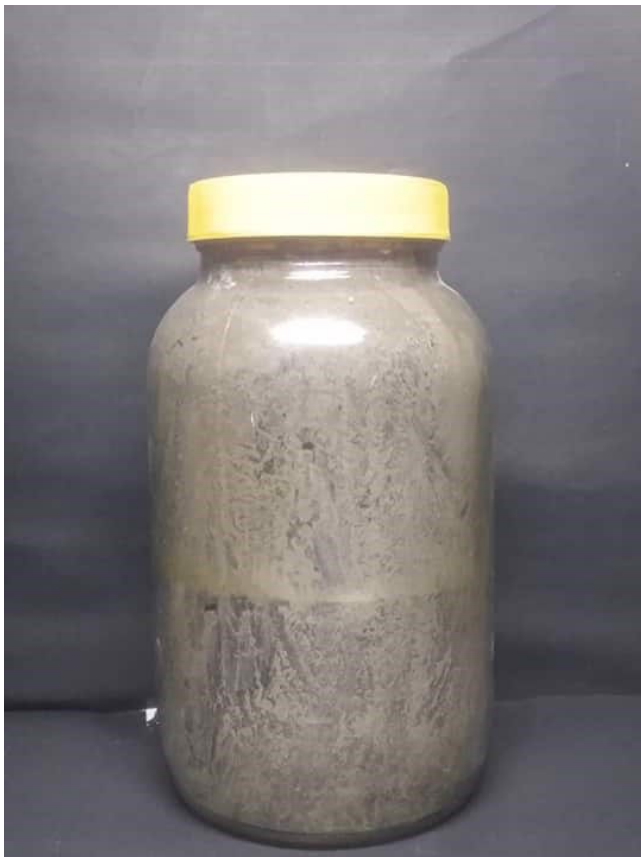

Figure 3. Soil Mixture After-Process – Before Settling



Figure 4. Soil Mixture After-Process – After Settling

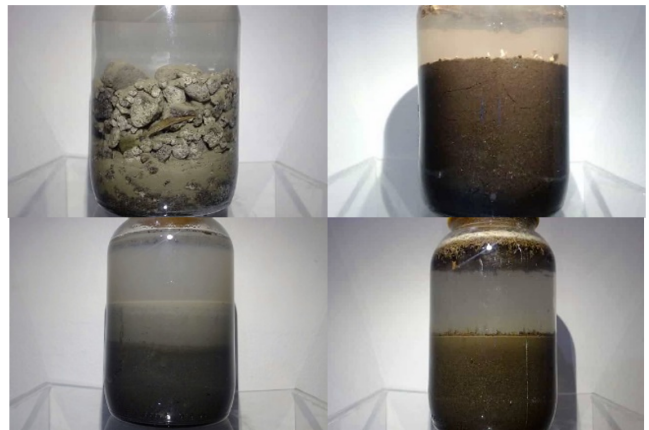

Figure 5. Soil Samples for Data Sets

process for the researchers to acquire in setting up the USoil Hardware.

The following materials are considered in the development of the hardware:

- **Illuminated Box:** Figures 7 and 8 shows the isometric, front, and top layout design for the illuminated box. The proposed illuminated box has a dimension of 22 x 18 x 17 inches. The width of the box was based on the right distance of the webcam and the jar. The height was measured to have a proper space for the light source that is placed above the jar. For the materials in the construction of the box, plywood was used to have a closed system, preventing the disturbances outside. Figure 8 shows also the illuminated box with labels.
- **White fluorescent bulb:** used to cover the area inside considering the field size, camera distance and surface of the jars used for the soil samples.

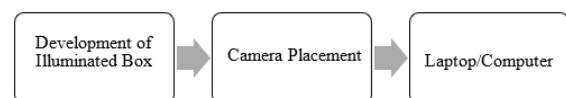

Figure 6. Block Diagram for the Hardware Development.

- Camera: Logitech HD Pro Webcam C920 was used with the specification of 30 frame rate per second which is suitable to produce clear image for the data sets. This is a form of video camera that feeds or streams an image or video to or through a computer to a computer network, such as the Internet, in real time. Webcams are generally tiny cameras that sit on a desk, are connected to a user's monitor, or are integrated into the gear itself. The Logitech HD Pro Webcam C920 is a type of HD Camera that is used for Widescreen Video Calling and Recording in desktop or laptop with 1080p quality and good frame rate. It is shown on Figure 9.

E. Software Development

- 1) Image Processing: The image processing system is divided into four techniques — image segmentation, image preprocessing, image acquisition and feature extraction [12], [13], [14], [15], [16], [17], [18], [19], [20]. Images of the samples are captured through the camera in image acquisition. As shown in Figure 10, the soil training sets are sent to the image preprocessing block and fetch the area of the soil regions and classified—silt, sand, gravel and clay. Noise reduction are implemented in image preprocessing and perform an image resize with 300x400 pixels. Regions in images are gathered and thresholding is performed in image segmentation. Through gray scaling, the edges of the object are cleaner and clearer by eliminating the pixels and smoothing of the image. Thus, making the object classified and counted, and saved to the database. Lastly, feature extraction is where color analysis is conducted. Resolution, pixel bit depth and color representation are the basic measurements in image processing. The types of measurements observed are indicating the edges, color, texture, size, position, and brightness (features humans basically understands). Thus, the features extracted in analyzing the soil samples is classified into different grades.

For the soil detection, the TensorFlow model for detection graph wherein the boxes, scores and classes of soil samples are present, and OpenCV for the input image are loaded to the memory. Below are the pseudo codes for the program made:

```
Variable A = tf.Graph from the variable, create as default:
variable B = tf.GraphDef with the graph file:
set variables to read, save/restore, and import the graph
set function to execute the program
```

The important libraries are imported, and the area of the soil is obtained through this module:

Utilize the mask parameter to set the threshold of the image, set a function to erode the image, and set a function to dilate the image. Add Ret/mask to set for threshold parameters. Another variable to use Bitwise "AND" during camera operations. Using

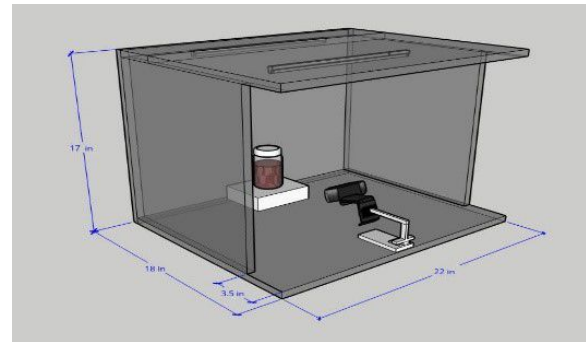

(a)

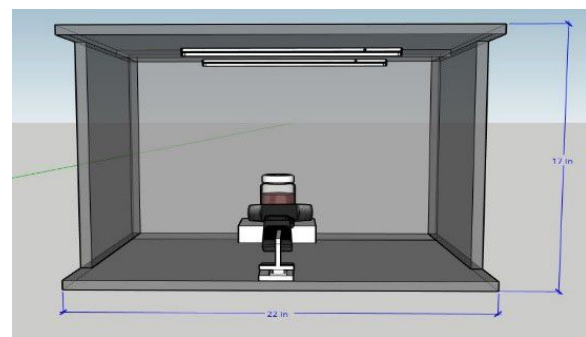

(b)

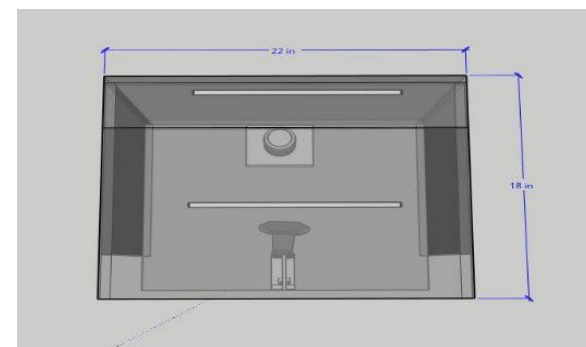
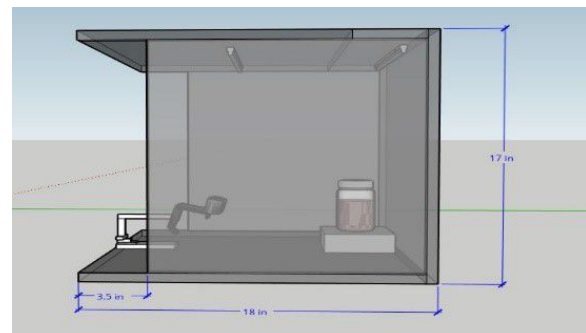

(c)

Figure 7. Illuminated box's (a) isometric view; (b) front view; (c) side view; (d) top view

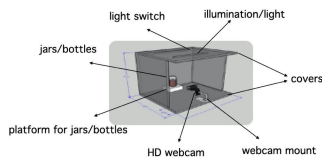

Figure 8. Prototype with Labels



Figure 9. Logitech HD Pro Webcam C920

Contour, utilize "if" loop for setting the maximum and minimum area of the image retrieved from the camera.

- 2) Training System: Utilizing the Google Colaboratory for the execution of Python files and Google Drive for the storage in training system section, the processed image will serve as the training sets or input of the project. The percentage level of different soil classification from the input will serve as the database for the system. Both soil classification and soil sub-classification is evaluated based on the Unified Soil Classification System. This will serve as the database for the system. These are the software used by USoil:

a) Python

Python is a programming language created by Rossum within 1980s that proceeds languages that

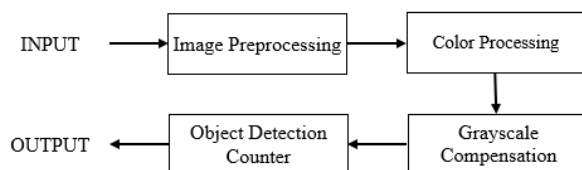

Figure 10. Soil Sample Image Processing System Block Diagram

are C, C++, Java, and C#. Python is simplified compared to the programming languages mentioned and provides powerful syntax. The said language, famous for the high-performance, interactive, object-oriented scripting language, is received by programmers as greatly readable. Unlike others, it utilizes English language with different punctuations and fewer syntax constructions.

b) Open-Source Computer Vision

Open-source Computer Vision (Open CV) is an open-source library that is specially applied for analysis of images and videos. With the use of Open CV, an individual can develop computer vision applications, real-time [18], [19], [21], [22].

Figure 11 shows the labelling or boxing of the data for the data set training. These will be converted to NumPy or .npy file format that will serve as the basis for the object analyzing model. The NumPy files will be uploaded to the google drive as the proponents will train it using a cloud service specifically, the Google Colaboratory.

c) TensorFlow

TensorFlow is imported for numerical computation and large-scale machine learning for this study and .npy files that contain all the images as the training sets uploaded and fetched from the Google Drive of USoil. The data sets are converted to comma-separated variable or .csv file format from the input data, the .npy files used in machine learning. Thus, making it more convenient for the training for its plain-text file format. Moreover, Inception v2 configuration in Faster R-CNN was uploaded in the Google drive and used due to its capability and faster than Fast R-CNN and R-CNN [17], [18], [23], [24], [25], [26].

d) Google Colaboratory

Google Colaboratory or widely known as Google Colab, is a free cloud service hosted by Google, that can be used with Machine Learning and Neural Network. The said tool allows collaborative editing, has preinstalled various libraries, and above all, offers free CPU, GPU, and TPU with the specifications shown in Table 2.4. Libraries are already installed was able to run python code interactively that is used together with Google Drive wherein data files can be loaded [27].

In Figure 12, the proponents have utilized Google Colaboratory to train the soil samples for the machine learning for high-end capabilities, its CPU, GPU and TPU. Training sets are fed to its cloud environment through Google Drive. Using these,

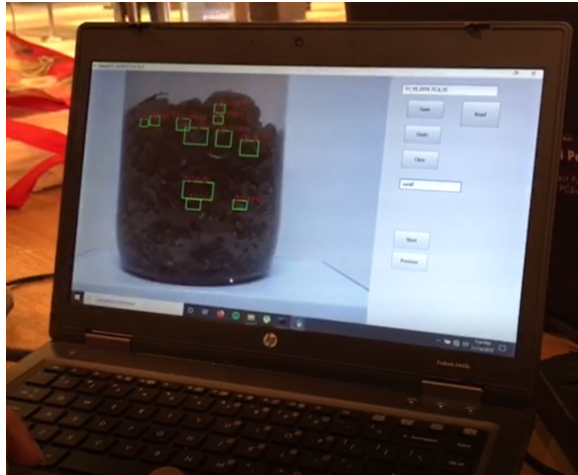

(a)

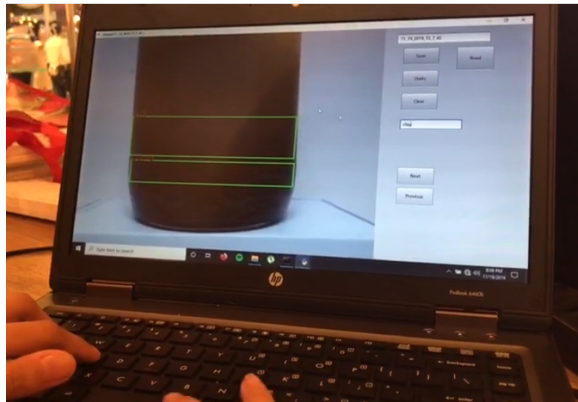

(b)

Figure 11. (a) Bounding boxes in OpenCV; (b) Soil regions set by different soil type using OpenCV

training time took time for 3-6 hours. the interface of Google Colab is shown as the proponents train the data sets allotted for training in USoil technology. TensorFlow is imported for numerical computation and large-scale machine learning for this study as shown in the first row. The other rows serve as the .npy files that contain all the images as the training sets uploaded and fetched from the Google Drive of USoil.

For the actual training of the data sets for soil classification through Google Colab is shown in Figure 13. Models and libraries are installed during the training for object detection. The data sets are converted to comma-separated variable or .csv file format from the input data, the .npy files used in machine learning. Thus, making it more convenient for the training for its plain-text file format.



Figure 12. Pre-training in Google Colab

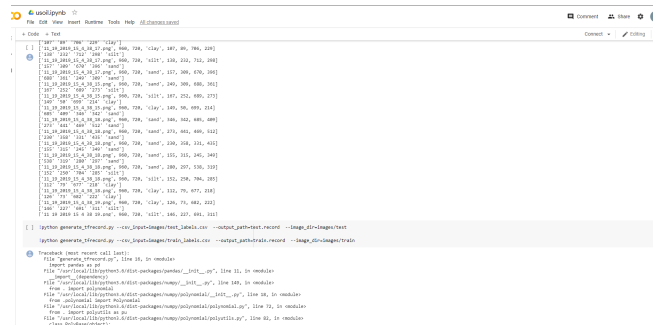

Figure 13. Training of Data Sets in Google Colab

The Python functions and the regions with Convolutional Neural Network will be compiled and exported as libraries into the Open CV. The USoil GUI allows the user to easily run the system. The compiled Python functions will be called in order to execute the image analysis for the soil samples. The proponents target in the GUI implementation is to be user-friendly, appealing and non-complex interface using the default Python module for standard GUIs, Tkinter. The proponents have developed the first version of GUI as shown in Figure 14.

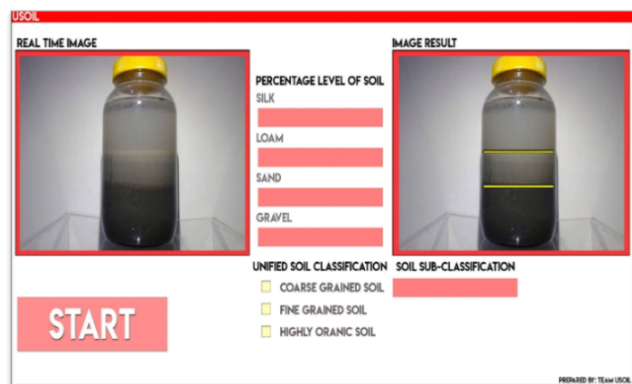

Figure 14. User Interface of USoil version 1

3) Graphical User Interface:

F. Design Implementation

In choosing the right illumination for image processing to achieve high quality photos of an object, the proponents considered the field size and camera distance and surface and shape of object, and chose the recommended color, white to cover a large area and to easily detect errors if a specific monochrome is added to the test subject. According to Stemmer Imaging, LED lights are the most used to implement with image processing. One of the illumination techniques is the direct front illumination which gives off a non-uniform image and can detect small details. The light is directly focused to the object. The acquired samples from the soil will be processed on image processing system and faster region-based convolutional neural network to produce more accurate result with the use of Camera, Computer and Illuminated box for soil. In choosing the right illumination for image processing to achieve high quality photos of an object, the proponents considered the field size and camera distance and surface and shape of object, and chose the recommended color, white to cover a large area and to easily detect errors if a specific monochrome is added to the test subject. According to Stemmer Imaging, LED lights are the most used to implement with image processing. One of the illumination techniques is the direct front illumination which gives off a non-uniform image and can detect small details. The light is directly focused to the object. The acquired samples from the soil will be processed on image processing system and faster region-based convolutional neural network to produce more accurate result with the use of Camera, Computer and Illuminated box for soil. Figure 15 shows the initial set-up of the needed hardware in order to determine soil classifications.

G. Convolutional Neural Network

There are two goals needed for the CNN. The first goal of this part is to let machines observe the surroundings as how the humans do, perceive it in a similar procedure, and with a multitude of tasks, use the knowledge like Classification and Image Analysis, Image and Video Recognition, Recommendation Systems, Media Recreations and Natural Language Processing. The second goal is for CNN to act as the algorithm used in the third objective of this study. CNN is a deep learning algorithm that takes an image, assign interests in learnable weights to a number of aspects in the images, and be in a position to assimilate one image into another [28]. Shown in Figure 16 is the structural process of the convolutional neural network in block diagram.

One of the popular types of CNN is Faster R-CNN (refer to Figure 17 for its mode of operation) for its computational efficiency, reduction in test time and performance improvement. The network of Faster R-CNN, as shown in Figure 18 consists of region proposal algorithm in order to generate “bounding boxes” in the image object detection, generation stage using Convolutional Neural Network and Region Proposal Network, prediction of classes in its classification layer and acquisition of coordinates in a box of the object bounding in its regression layer [29]. The



Figure 15. Initial setup of the Illuminated Box

purpose of choosing Faster R-CNN for the algorithm is due to its nature of providing fast speed of analyzing during the system's “Image Upload” and the “Real-time Analysis” operation. The classification of image was utilized through image upload and through real-time in a short time.

H. Testing Procedures

In this, the project is operating on how it is constructed. The estimated level of soil grading will be determined.

- 1) Test the efficiency of camera that will be used to capture image samples by manual checking if it gives clear result in real-time and image upload. Accomplish multiple tests of camera performance by using it indoors, outdoors, and with adjusting number of lights to determine if the camera fits perfectly as required by the system.
- 2) Test the accuracy and effectiveness of the system in estimating capability of grading of soil using the device compared to conventional way. Conduct 200 sample test using the system and the conventional way like sieving. Through collection of data after the tests, compute percentage errors and differences to see how accurate and effective it can be.
- 3) Test the overall system if it functions properly and runs simultaneously. Run the real-time capturing mechanism of the system as well as the uploaded image assessment and observe if there's any inconsistency in the results after several repetitions.

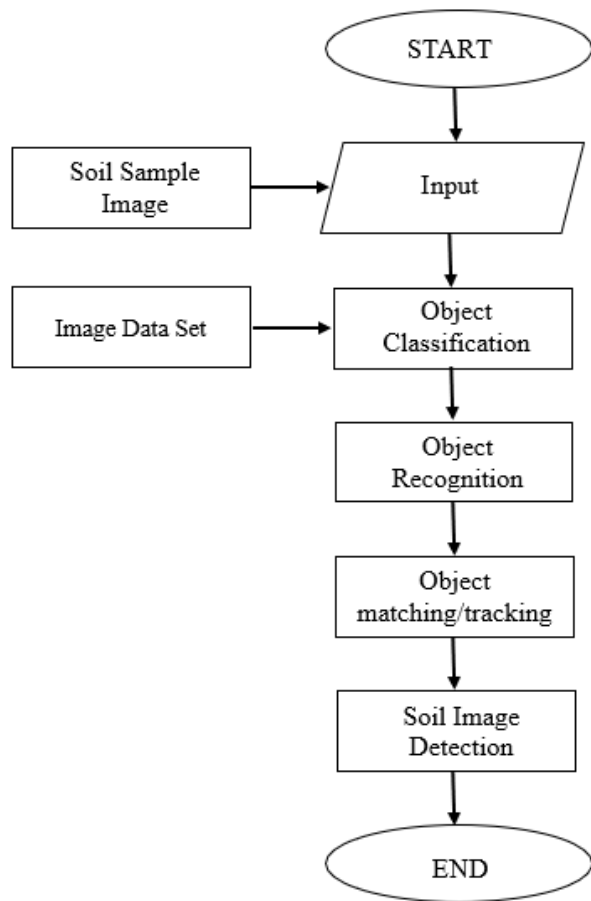

Figure 16. Convolutional Neural Network Flowchart for Training Data Sets



Figure 17. Faster R-CNN's Mode of Operation

3. RESULTS AND DISCUSSION

This section provides numerical data gathered concerning system data analysis, system efficiency, and soil grading accuracy based on multiple testing phases, presented through tabulation and statistical presentation.

USoil's original aim is to see if digital image processing, with the help of convolutional neural network, can be used as a more reliable soil classification method, eliminating erroneous human interaction. Through the utilization of newer technology, the classification of soil can be computerized while remaining highly accurate and efficient from training phase up to deployment.

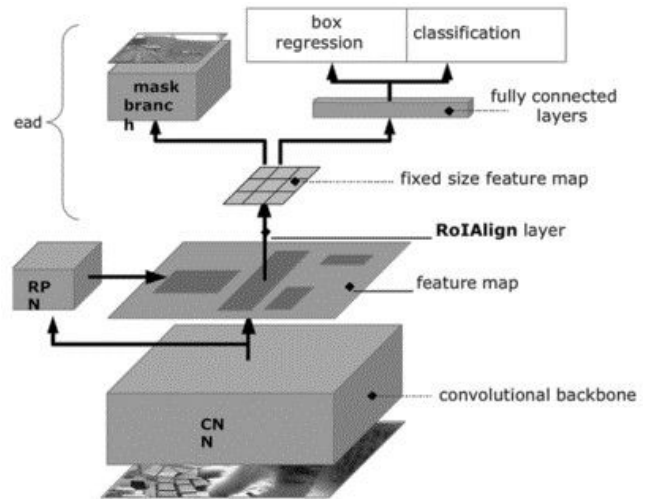

Figure 18. Faster R-CNN's Architecture [24]

A. Basic Procedure of the Unified Soil Classification System

The soil samples are manually collected and placed through the Jar Test for separation of soil types. The jar is then placed at the center of the illuminated box, then the image is captured with a webcam. The image taken is saved in the program and undergo digital image processing and convolutional neural network to acquire a precise and accurate result. The Graphical User Interface was made with Microsoft Visual Studio as a platform to show the image taken and the USCS-based classification of the soil sample.

B. Illuminated Box Findings

The illuminated box provided as a uniform place to capture images and its black background significantly reduced the reflection of the light source. The Jar Test suited the best for the approach the proponents intended. The programming language used for soil classification was Python and Google Colab for its four-part image processing: image acquisition, image segmentation, extraction and finally, Grading classification. The design of the Graphic User Interface, since implementing the second design, remarkably eased the determination of the Main and Sub-Classification of soils with the help of Image Upload and Real-time Capture features.

The interior of the illuminated box is as important as the outside. Any distractions from the light coming from the environment can and will alter the image quality that the proponents best find. With that, the position of the camera, the mason jar with the soil mixture, the lighting, and the interior background of the box should be considered. With the huge interior of the box, the position of the jar and the camera can occupy any place in the box but with the lighting and the background, consideration will be needed. The illumination was positioned at the middle area above the interior of the box for the best lighting possible. And then there is the background. Initially, white background



Figure 19. Jar Reflection

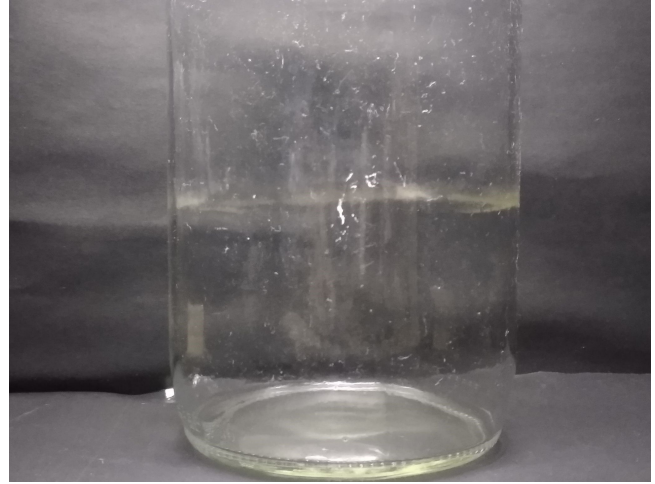

Figure 21. With Black Interior

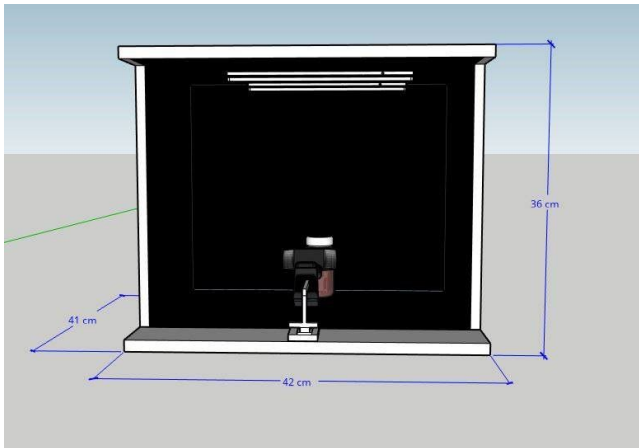

Figure 20. Illuminated Box Black Interior - Initial Design

was used but proved to be intrusive on the image analysis. The light source reflects too much on the white background and into the jar, hampering Soil analysis. Image quality is a very important aspect for quality soil analysis especially in feeding data into the machine learning that the proponents developed. Figure 19 shows that the jar reflects the opening of the illumination box.

Then, the authors decided to apply black as background, through research and trial and error [30], and it reduced the reflected light source on to the jar significantly. Figure 20 showed the initial design of the illuminated box. Figure 21 shows the effect of the black background inside the illuminated box

The inner section of the illuminated box is the space for the acquisition of images of the Jar Soil Sample. The space inside is well-lit by the light source that was placed above the sample and the camera. The dimension of 22 x 18 x 17 inches. The laptop is placed at the top of the box. Also, the illuminated box is made to be foldable in order for the



Figure 22. Interior of Illuminated Box

users to be able to designate it into desired places anywhere within the vicinity. Figure 22 is the prototype developed by the authors after extensive research, considerations and recommendations.

Figure 23 shows the complete set-up of the needed hardware in order to determine soil classifications. From the top part of the image, the roof of the illuminated box offers as a space for laptops to be placed. The proponents of the research used black-colored interior for the illuminated box.



Figure 23. Complete Set-up of USoil

C. Graphic User Interface of USoil

Figure 24 shows the Graphic User Interface of USoil. The USoil Classifier contains three parts: Image Box, Image Selector, and Result Section.

- 1) The Image Box displays the image to be classified. The quality of the image depends on how the camera is positioned across the mason jar with the soil mixture. Manual inspection is highly recommended before proceeding in capturing an image.
- 2) The Image Selector allows user to choose between Real-time Capture and Upload of Pre-captured Image. Real-time Capture displays the live feed of the camera in 1080p and 30 frames per second. The soil classification will be revealed in real-time as well, including the Main Classification and Sub-Classification. In Pre-Captured Images, the result will be revealed after capturing a photo and then after uploading an image. Whether the image is taken from the site or from a third party, the USoil will provide a result. Stability of both the illuminated box and the camera pointed towards the jar is important before capturing an image.
- 3) The Result Section allows users to determine the Percentage of soil types from the image, as well as

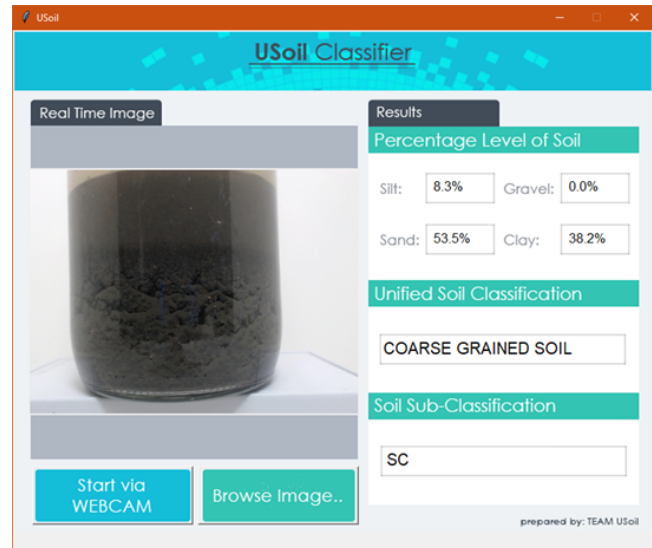

Figure 24. User Interface of USoil version 2

its USCS Classification and Sub-Classification. The USoil GUI produces a result within a short amount of time due to the nature of R-CNN's having the lowest inference time among the different types of CNN. This characteristic saves a lot of time in analyzing soil in real-time deployment.

From the 10 soil data sets, the following presented are the summary results of the comparative study:

D. Soil Classification using Unified Soil Classification System

Training and duration took time for 3-6 hours. From the 10 testing sets, both soil classification and soil sub-classification using USCS acquired resulted in all of them yields to 92.4% accurate.

E. Percentage Level of Soil

The project accurately provided the percentage of 10 soil sample test sets in different classifications—silt, sand, gravel, and clay as shown in Tables I & II. Soil Grading between using the conventional way and using USoil technology are shown in Table I. Table I shows the Conventional and the USoil Soil Classification Accuracy test results. Different soil compositions were arranged in order to provide evidence that the system is accurate. In Table II, the USoil algorithm provided the Main and Sub Classifications of each sample taken using the system, in accordance with the Standards given by the USCS. In Table III, the percent differences of each soil type were computed for Conventional and the USoil methods. The computation showed the following percentage differences: 7.45% for silt, 10.22% for sand, 3.78% for gravel, and 8.97% for clay which yields to a total percent difference of 7.6% using the 10 soil sample test sets. As shown, sand has the highest percent difference due to its characteristic being small in composition and can be easily



TABLE I. Results in Soil Classification Accuracy Test

Sample No.	Conventional				Using USoil			
	Silt	Sand	Gravel	Clay	Silt	Sand	Gravel	Clay
1	0%	50%	50%	0%	0%	54.37%	45.63%	0%
2	10%	50%	0%	40%	8.30%	53.30%	0%	38.20%
3	35%	25%	0%	40%	33.42%	24.24%	0%	42.14%
4	10%	11%	15%	65%	10.52%	11.83%	13.84%	63.61%
5	65%	25%	0%	10%	64.85%	23.50%	0%	11.45%
6	10%	15%	70%	5%	7.58%	15.31%	70.19%	6.72%
7	5%	40%	50%	5%	5.42%	37.70%	52.21%	4.47%
8	50%	5%	0%	45%	52.34%	2.73%	0%	44.73%
9	5%	70%	15%	10%	5.32%	68.45%	16.76%	9.27%
10	0%	75%	20%	5%	0%	76.48%	19.04%	4.28%

TABLE II. Results in USCS-Based Soil Classification Accuracy Test

Sample No.	Conventional		Using USoil	
	Unified Soil Classification	Soil Sub-Classification	Unified Soil Classification	Soil Sub Classification
1	Coarse-Grained Soil	SP	Coarse-Grained Soil	SP
2	Coarse-Grained Soil	SC	Coarse-Grained Soil	SC
3	Fine-Grained Soil	ML	Fine-Grained Soil	ML
4	Fine-Grained Soil	CL	Fine-Grained Soil	CL
5	Fine-Grained Soil	MH	Fine-Grained Soil	MH
6	Coarse-Grained Soil	GW	Coarse-Grained Soil	GW
7	Coarse-Grained Soil	GM	Coarse-Grained Soil	GM
8	Fine-Grained Soil	OL	Fine-Grained Soil	OL
9	Coarse-Grained Soil	SP	Coarse-Grained Soil	SP
10	Coarse-Grained Soil	SW	Coarse-Grained Soil	SW

TABLE III. Percent Difference Between Conventional and USoil

Soil Type	% Difference
Silt	7.45%
Sand	10.22%
Gravel	3.78%
Clay	8.97%
Total	7.6%

mixed with other soil types. Gravel being the lowest due to its bigger size compared to other types.

F. Comparison of USoil to Previous Works

Table IV compared USoil into other works. This table included the amount of dataset images, soil types, the type of algorithm used, and the accuracy of each previous works. As indicated, even though the USoil had less datasets compared to other works, it still obtained a significant accuracy of 92.4%. It showed that the USoil can obtain a higher accuracy given that datasets are increased up to at least a thousand more. The work at [6] used ANN compared to this study that used R-CNN. R-CNN was proven to be much faster in computation compared to ANN while being as accurate if not, more accurate than ANN.

G. USoil Evaluation

The evaluation of the project focused on comparing the results of Conventional and USoil methods. The USoil classifier resulted up to 7.6% average percent difference compared to the Conventional method of soil classifying. The data collected was less accurate due to the current pandemic; resulting in less data acquisition normally planned and needed. Furthermore, even with less data used, the USoil classifier was proved to work accurately and efficiently during its testing phase, with the system showing an excellent working condition.

4. CONCLUSION

This study successfully classified soil samples using R-CNN. It only focused solely on USCS standards including Main Classification and its Sub-Classification. The USCS-based soil classifier or USoil Technology is focused to the assessment of soil types, particle size (Gravel, Sand, Silt and Clay) and soil grading, a coarse-grained soil and a fine-grained soil having its sub classification.

The development of the program that provides an efficient soil assessment in identifying the grading and percentage of different soil types – silt, clay, gravel and sand was successfully implemented through Python. The system only used about 300 image samples. The impact of



TABLE IV. Comparison With Previous Works

	This work	[3]	[6]	[7]	[8]
Number of Dataset Images	300	Unspecified	1000	2045	1988
Soil Types	Clay, Gravel, Sand, Silt	Clay, Gravel, Sand, Silt, Organic	Soil-Rock Mixture	General Soil Mixture	General Soil Mixture
Algorithm	Faster Regional Convolutional Neural Network (Faster R-CNN)	Support Vector Machine (SVM)	Color Space, Artificial Neural Network (ANN)	k-Nearest Neighbor (k-NN), Bagged Trees, Gaussian kernel-based SVM	Linear Regression, J48 (C4.5)
Drawbacks	Low Dataset	Low Accuracy	Focused more on rocks instead of soil types	Accuracy is taken from the average of three algorithms	Low Dataset-to-Accuracy Ratio
Accuracy	92.4%	82.35%	95%	92.93%	91.9%

using lesser number of samples tend to make the system less accurate. However, with limited samples, the project was able to provide the evaluation of soil classification based on Unified Soil Classification System with 92.4% accuracy. The “Image Upload” and “Real-time Analysis” were successfully applied and utilized into the GUI through the use of an external camera.

Based on the result and findings of the research, future work includes several technological inventions mentioned below. The project is successfully done; however, the authors would like to make the following recommendations to further improve the project:

- 1) Collect more soil samples as an additional data set for more accurate results.
- 2) Develop a mobile and web platform of the program.
- 3) Automate some of the procedural part or replace a procedure for the Jar Test.
- 4) Develop a more compact and portable design for the illuminated box.
- 5) Allow data from the GUI to be printed through wired and wireless connection.

ACKNOWLEDGMENT

The authors dedicate the completion of this study to the Technological University of the Philippines, especially to the University Research and Development Services Office, for the resources, support, and partial funding granted.

REFERENCES

- [1] B. Elmendorf, “Understanding tree planting in construction-damaged soils.” [Online]. Available: <https://extension.psu.edu/understanding-tree-planting-in-construction-damaged-soils>
- [2] R. A. Garcia-Gaines and S. Frankenstein, “Usdc and the usda soil classification system: Development of a mapping scheme.” [Online]. Available: <https://hdl.handle.net/11681/5485>
- [3] P. A. Harlianto, T. B. Adji, and N. A. Setiawan, “Comparison of machine learning algorithms for soil type classification,” in *2017 3rd International Conference on Science and Technology - Computer (ICST)*, ser. ICST '17. Yogyakarta, Indonesia: IEEE, Jul. 2017, pp. 7–10.
- [4] P. Yang, H. Zhilei, Z. Zhende, J. Zhijian, and S. Memetyusup, “Research on the mesoscopic identification method of digital images of soil-rock mixture,” in *2014 7th International Conference on Intelligent Computation Technology and Automation*, ser. ICICTA '14. Changsha, China: IEEE, Oct. 2014, pp. 583–586.
- [5] W. Tian, Y. Shao, and Y. Hu, “3d damage identification of soil rock mixture based on image processing technology,” in *IOP Conference Series: Materials Science and Engineering*, ser. ACMME '18. Xishuangbanna, Yunnan, China: IOP, Jul. 2018, pp. 1–7.
- [6] L. Ye, G. Chao, and C. Guojian, “Rock classification based on images color spaces and artificial neural network,” in *2014 Fifth International Conference on Intelligent Systems Design and Engineering Applications*, ser. ISDEA '14. Hunan, China: IEEE, Jun. 2014, pp. 897–900.
- [7] S. A. Z. Rahman, K. C. Mitra, and S. M. M. Islam, “Soil classification using machine learning methods and crop suggestion based on soil series,” in *2018 21st International Conference of Computer and Information Technology (ICCIT)*, ser. ICCIT '18. Dhaka, Bangladesh: IEEE, Dec. 2018, pp. 1–4.



- [8] J. Gholap, A. Ingole, J. Gohil, S. Gargade, and V. Attar, "Soil data analysis using classification techniques and soil attribute prediction," *International Journal of Computer Science Issues (IJCSI)*, vol. 9, no. 3, pp. 1–4, May 2012.
- [9] N. Arago, J. Orillo, J. Haban, J. Juan, J. Puno, J. Quijano, and G. Tuazon, "SoilMATE: Soil macronutrients and ph level assessment for rice plant through digital image processing using artificial neural network," *Journal of Telecommunication, Electronic and Computer Engineering (JTEC)*, vol. 9, no. 2-5, pp. 145–149, Jun. 2017.
- [10] R. Gandhi, "R-CNN, Fast R-CNN, Faster R-CNN, YOLO - object detection algorithms." [Online]. Available: shorturl.at/beovC
- [11] A. H. Jeffers, "Soil Texture Analysis "The Jar Test"." [Online]. Available: <https://hgic.clemson.edu/factsheet/soil-texture-analysis-the-jar-test>
- [12] F. Mendoza and R. Lu, "Basics of image analysis," in *Hyperspectral Imaging Technology in Food and Agriculture*. Springer, 2015, pp. 9–56. [Online]. Available: https://link.springer.com/chapter/10.1007/978-1-4939-2836-1_2
- [13] L. K. S. Tolentino and D. M. T. Beleno, "Development of a 3d disparity estimation processing architecture," *International Journal of Applied Engineering Research*, vol. 12, no. 19, pp. 8420–8424, Oct. 2017.
- [14] L. K. S. Tolentino, J. W. F. Orillo, P. D. Aguacito, E. J. M. Colango, J. R. H. Malit, J. T. G. Marcelino, A. C. Nadora, and A. J. D. Odeza, "Fish freshness determination through support vector machine," *Journal of Telecommunication, Electronic and Computer Engineering (JTEC)*, vol. 9, no. 2-5, pp. 139–143, Jun. 2017.
- [15] L. K. Tolentino, R. M. Aragon, W. R. Tibayan, A. Alvisor, P. G. Palisoc, and G. Terte, "Detection of circulatory diseases through fingernails using artificial neural network," *Journal of Telecommunication, Electronic and Computer Engineering (JTEC)*, vol. 10, no. 1-4, pp. 181–188, Jan. 2018.
- [16] L. K. S. Tolentino, E. J. G. Enrico, R. L. M. Listanco, M. A. M. Ramirez, T. L. U. Renon, and M. R. B. Samson, "Development of fertile egg detection and incubation system using image processing and automatic candling," in *TENCON 2018 - 2018 IEEE Region 10 Conference*, ser. TENCON '18. Jeju, Korea (South): IEEE, Oct. 2018, pp. 0701–0706.
- [17] L. K. S. Tolentino, R. O. S. Juan, A. C. Thio-ac, M. A. B. Pamahoy, J. R. R. Forteza, , and X. J. O. Garcia, "Static sign language recognition using deep learning," *International Journal of Machine Learning and Computing*, vol. 9, no. 6, pp. 821–827, Dec. 2019.
- [18] N. M. Arago, C. I. Alvarez, A. G. Mabale, C. G. Legista, N. E. Repiso, R. R. A. Robles, T. M. Amado, R. J. L. Jorda, A. C. Thio-ac, J. S. Velasco, and L. K. S. Tolentino, "Automated estrus detection for dairy cattle through neural networks and bounding box corner analysis," *International Journal of Advanced Computer Science and Applications (IJACSA)*, vol. 11, no. 9, pp. 303–311, Sep. 2020.
- [19] L. K. S. Tolentino, C. P. D. Pedro, J. D. Icamina, J. B. E. Navarro, L. J. D. Salvacion, G. C. D. Sobrevilla, A. A. Villanueva, T. M. Amado, M. V. C. Padilla, , and G. A. M. Madrigal, "Weight prediction system for Nile tilapia using image processing and predictive analysis," *International Journal of Advanced Computer Science and Applications (IJACSA)*, vol. 11, no. 8, pp. 399–406, Aug. 2020.
- [20] L. K. S. Tolentino, E. O. Fernandez, S. N. D. Amora, D. K. T. Bartolata, J. R. V. Sarucam, J. C. L. Sobrepeña, and K. Y. P. Sombol, "Yield evaluation of brassica rapa, lactuca sativa, and brassica integrifolia using image processing in an IoT-based aquaponics with temperature-controlled greenhouse," *AGRIVITA, Journal of Agricultural Science*, vol. 42, no. 3, pp. 393–410, Sep. 2020.
- [21] R. Laganière, *OpenCV Computer Vision Application Programming Cookbook*. Birmingham, UK: Packt Publishing Ltd, 2014.
- [22] J. S. Velasco, A. A. V. Beltran, J. A. C. Alayon, P. E. B. Maranan, C. M. A. Mascardo, J. M. B. Sombrito, and L. K. S. Tolentino, "Alphanumeric test paper checker through intelligent character recognition using OpenCV and support vector machine," in *World Congress on Engineering and Technology; Innovation and its Sustainability*, ser. WCETIS '18. Manila, Philippines: Springer, Cham, Nov. 2018, pp. 119–128.
- [23] S. Yegulalp, "What is TensorFlow? The machine learning library explained." [Online]. Available: <https://www.infoworld.com/article/3278008/what-is-tensorflow-the-machine-learning-library-explain-ed.html>
- [24] K. He, "Mask r-cnn." [Online]. Available: <https://www.slideshare.net/windmdk/mask-rcnn>
- [25] L. K. Tolentino, R. A. C. Alpay, A. J. N. Grutas, S. J. B. Salamanes, R. J. C. Sapiandante, and M. B. Vares, "An automated egg incubator with Raspberry Pi-based camera assisted candling and R-CNN-based maturity detection," *International Journal of Computing and Digital Systems*, vol. 11, no. 1, pp. 303–313, Jan. 2022.
- [26] J. Velasco, C. Pascion, J. W. Alberio, J. Apuang, J. S. Cruz, M. A. Gomez, B. J. Molina, L. Tuala, A. Thio-ac, and R. J. Jorda, "A smartphone-based skin disease classification using MobileNet CNN," *International Journal of Advanced Trends in Computer Science and Engineering*, vol. 8, no. 5, pp. 2632–2637, Sep. 2019.
- [27] M. Konkiewicz, "Deep Learning in a cloud. How to get started with Google Colab and why?" [Online]. Available: <https://towardsdatascience.com/deep-learning-in-a-cloud-how-to-get-started-with-google-colab-and-why-d07874c5e833>
- [28] S. Saha, "A Comprehensive Guide to Convolutional Neural Networks — the ELI5 way." [Online]. Available: <https://towardsdatascience.com/a-comprehensive-guide-to-convolutional-neural-networks-the-eli5-way-3bd2b1164a53>
- [29] S. Ananth, "Faster R-CNN for object detection." [Online]. Available: <https://towardsdatascience.com/faster-r-cnn-for-object-detection-a-technical-summary-474c5b857b46>
- [30] A. C. Society, "Uncover through science what makes black color the way it is and how researchers are developing the real pure version of black." [Online]. Available: <https://www.britannica.com/video/187042/colour-black-way-researchers-versions>



Gilfred Allen M. Madrigal Gilfred Allen M. Madrigal presents as one of the Faculty Members of Technological University of the Philippines, Manila, Department of Electronics Engineering. While a faculty member, he also takes his Master's degree at TUP-Manila. Presently, he is a member of the Technical Committee on Cleanrooms of the Bureau of Product Standards of the Philippines' Department of Trade and Industry (TC 83).

try (TC 83).



Roel Ryan F. Galos Roel Ryan F. Galos is a degree holder of BS in Electronics Engineering at the Technological University of the Philippines, Manila, and an active member of IECEP and OECES.



Adrian L. Beltran Adrian L. Beltran is a degree holder of BS in Electronics Engineering at the Technological University of the Philippines, Manila, a DOST Scholar from 2015-2018 and an active member of IECEP-MSc and OECES during his college years. He graduated high school as Class Valedictorian.



Jeffrey Karl H. Roca Jeffrey Karl H. Roca graduated high school as a silver medal awardee at St. Thomas More Academy. He is a degree holder of BS in Electronics Engineering at the Technological University of the Philippines, Manila, and an active member of IECEP and OECES during his college years.



Sean Paul Andrei F. Diaz Sean Paul Andrei F. Diaz is a degree holder of BS in Electronics Engineering at the Technological University of the Philippines, Manila, and an active member of IECEP-MSc and OECES. He is a passer of Electronics Technician Licensure Exam of October 2018.



Camille Ann V. Santos Camille Ann V. Santos is a degree holder of BS in Electronics Engineering at the Technological University of the Philippines, Manila, a DOST Scholar from 2015-2019 and an active member of IECEP and OECES during his college years. She is a passer of Electronics Technician Licensure Exam of October 2018.