



A Comprehensive Approach for A Smart Medication Dispenser

Abdallah Kassem¹, Wissam Antoun¹, Mustapha Hamad¹ and Chady El-Moucaray¹

¹Department of Computer and Communication Engineering, Faculty of Engineering, Notre Dame University-Louaize
Zouk Mosbeh, P. O. Box: 72, Zouk Mikael

Received 12 Jan. 2019, Revised 15 Feb. 2019, Accepted 25 Feb. 2019, Published 1 Mar. 2019

Abstract: This paper presents a comprehensive approach for a Smart Medicine Dispenser (SMD) prototype. The main purpose of the proposed system is to help patients, mainly seniors and elderly people, take their medications on time in an easy manner without the possibility of skipping pills and thus reducing the risk of accidental over/under dose treatment. Failing to take medications promptly can have serious consequences on patients including delay in recovery, occurrence of other illness and even death. The SMD could then help avoiding such serious health issues by alerting patients to take the appropriate dose of medicine at the right time. In addition, it provides a direct communication channel between patients and caregivers by immediately notifying them in case the patients miss their pills. This system will also be of great benefit to doctors, healthcare professionals, insurance and pharmaceutical companies, as it will log medication data and statistics that can be analyzed later. Moreover, the SMD provides patients and caregivers with a user-friendly touch interface available as an application on their smartphones which allow them to remotely manage and control the pill schedules and review medication adherence logs.

Keywords: Instrumentation, Smart Medicine, Pill Dispenser, Android Application, PillBox, Microcontroller

1. INTRODUCTION

Medication adherence by patients has always been a great concern throughout the healthcare industry which includes doctors, healthcare professionals, and other stakeholders (e.g., insurance and pharmaceutical companies); mainly because elderly or senior patients have a serious problem with drug misuse [1]. It is very likely for them to forget to take their pills on time, especially patients who take multiple medications concurrently. In addition, they may take wrong dosage accidentally which will lead to sever consequences on their health and life (i.e., death [2]). Finding an effective solution to tackle this problem is highly significant.

Grey, et al. [3] from the University of Washington have conducted a research study on medication adherence in three home healthcare agencies. The study included one hundred forty-seven senior participants taking three or more medications regularly. The results showed that 30.6% participants were under adherent while 18.4% were over adherent with at least one medication.

The main objective of the Smart Medicine Dispenser system is to assist senior patients in taking their

medications regularly without the possibility of missing pills. It helps them also avoiding accidental over/under dose.

The article is organized as follows. In section II, we present the related works about the SMD. In Section III, we describe the method used for the system development. In Section IV we discuss the results and finally in section V we conclude the paper.

2. RELATED WORKS

Several models of pill dispenser devices are available in the market. These devices, produced by different companies, consist of a built-in alarm to notify the users without any personal database to save the patients data or remote access functionality. In the following section, we discuss some of the available SMD machines:

A. Weekly Electronic Pills Dispenser with Circular containers [4], is a medication dispenser that relies on a PIC microcontroller to rotate seven circular containers attached to a servo motor with each container having 4 sections that corresponds to 4 medication servings per day for the 7 days of the week. The interface of the system is a 2-Line LCD with some navigation buttons that lets the user edit the time intervals at which the pills will be



served. When it's time for the medication, one section of the container will be released and an audio alarm will be generated. The developers suggested to add a SMS notification tool to alert the patients who forgot to take their pills on time.

B. Pill Dispenser with Alarm Via Smart Phone Notification [5], is a pill dispenser that uses an Arduino Microcontroller connected to an RTC module to provide the time and date, servo motors that open the gate of one of the three box containers, a vibration motor that forces the pills out of the container, IR sensors that detects the number of pills that has fallen which will make the operation stop whenever the desired number of pills is met. An LCD with several buttons is the main interface of the dispenser. When it is time to take the pill the Arduino will signal a Raspberry Pi B+, which will then push a notification to the patient on her/his smartphone using the Instapush application.

C. The Autonomous Pill Dispenser: Mechanizing the Delivery of Tablet Medication, is a project with an Arduino controlled device, that emphasis on dispensing the exact amount of medication on the correct time using a textured cone that can precisely trap one pill at a time. The device uses an Android application that enables the caretaker of configuring the pill schedule and then sends a serial Bluetooth signal via the HC-06 module to the Arduino when it is time to take medication, the app will also send a SMS notification to patients to remind them to take the pills [6].

D. A study by Ranjith and Mahalaxmi [7], talks about the advantages of using Mini Tablets with diameters equal to or smaller than 2–3 mm, and on how using an automatic Dose dispensing device that can help spread this new kind of pills. The device comprises a cassette that holds the micro tablets, with a display to view and adjust the dose. It is a handheld, easy to use, battery powered device [7].

E. Advanced Medication Dispenser [8], is a proposed system that uses a Digilent Chipkit that is connected to an EEPROM to store the drugs information, a buzzer to signal the alarm, 2 servo motor that controls the container, RFID for user identification and to a Wi-Fi shield to enable remote monitoring for the pills. The Dispenser uses an LCD module with 2 capacitive buttons to interface with the user. When it is time to take the pill, a timer will start and the buzzer will start ringing while showing a message on the LCD screen, the user has to identify himself or herself using an RFID tag to take the pill and stop the timer and buzzer and the pill will be registered as Administrated. If the user exceeds the timer threshold the buzzer will stop and the pill state will be changed to missed. Pill states can be seen remotely via a webserver with user authentication.

F. The Automated Pill Dispenser Project [9] aims to test the assumption that using an automated medication dispensing device enables people to enjoy improved quality of life, remain independent at home for longer and be less reliant on health and social care services (thus reducing costs to these economies). The Target groups were people with memory and mental health issues, physical difficulties, patients with long term medical conditions. The feedback from the clients and Caretakers about the impact of the automatic pill dispenser has been overwhelmingly positive. Data collected during this project indicates a significant saving of £1700 per person over a six-month period, coming from reduced house visits to prompt people to take their medication and an absence of hospital admissions for anyone using the pill dispenser. Pill dispensers were found to be reliable with little to no issues reported, these small issues coming from people who took a few days to get used to it and often needed a reminder of how the device works and what to do when the alarms sound.

G. SINICA Medication Dispenser describes an advanced multithreaded machine that takes a new approach on the dispensing and scheduling mechanisms. The device relies on predefined scheduling information called MSS (medication schedule specification). The MSS is generated by a pharmacist along with RFID tagged containers. The dispenser shown in Figure 1 has a number of sockets on its base, an indicator light around each socket, an alarm device, a LED display, a Push-To-Dispense (PTD) button, verification boxes, a dispensing cup and a memory card reader, and an RFID reader. To fill the dispenser, the user plugs the MSS in the card reader and the new containers into the empty sockets, the dispenser will automatically map the containers to the sockets. Shortly before each dose time, the dispenser uses the reminder devices to tell the user to come to retrieve and take medication(s). In response to the reminder, the user reports to the dispenser by pushing the PTD button. Because the amount of time the user takes to respond to a reminder may vary widely, the dispenser updates the dose size of each medication due to be taken when the PTD button is pushed. The dispenser will light up around the container and will allow the pickup from the socket, and when the user picks up the container, the display will show the dose size and will wait for the user to place the pill back in the machine where a camera will verify the right dosage and will use the display to instruct for any necessary correction [10].



Figure 1. SINICA smart dispenser [10]

H. A highly scalable with remote manageability smart medication dispenser was proposed in [11]. The system offers a Multiuser environment for a high degree of scalability (i.e., Hospitals, nursing homes), Remote Management Operations for a High Degree of Manageability which are compatible with Open Mobile Alliance (OMA) Device Management (DM) protocol in order to overcome the bandwidth limited networks problem, Medication State Transmission, Monitoring Servers, Embedded Programs Management operations (i.e., System Update), Operational Errors Management and more. A dispensing prototype is shown in Figure 2. This smart medication dispenser allows multiple users to use a single medication dispenser, thus providing scalability to the device. It also allows medical staff and system administrators, instead of end users, to manage medication dispensers, thus leading to cost efficiency and safe operation of the device. Medications for each patient are stored in a medication cartridge and a cartridge is placed in a Medication dispenser tray [11].

I. e-pill MedTime STATION Automatic Pill Dispenser (Figure 3), is a commercial product available in the market that uses a pre-labeled ring to store pills and allows for up to 6 alarms per day (28 medication events). It can also prevent double dosing by locking the remaining medicines. The user simply moves the blue handle forward to dispense medications into the medicine cup. The alarm/blinking light is automatically turned off [12].



Figure 2. Smart medication dispenser with two medication dispensing tray [11]



Figure 3. e-pill MedTime STATION Automatic Pill Dispenser [12]

The proposed SMD system takes the idea of automated dispenser to the next level as it has smart features that do not exist in any other automated dispenser. The system relies on a smartphone application as the center of operation instead of being incorporated into the machine, which offers the best User Interface since most of the patients are familiar with touch screens and applications and thus, need not be trained or exert special effort or have particular knowledge about the usage of the SMD. Furthermore, SMD would allow the patient to view, edit her/his schedule remotely without the need of having the machine in close proximity for direct access. In addition, a personal account is provided for each patient where no one else can access except her/his caregiver person. In addition, statistical or historical data is provided about the pills and their administration dates, and the remaining ones, as well.

3. SMART MEDICINE DISPENSER METHODOLOGY

This section describes the organizational structure of the proposed prototype and encompassing the SMD design with its peripherals [13]. An Android application is developed that is responsible for controlling the whole system as it constitutes the primary interface. The application stores its data on a cloud and performs synchronization upon login. To dispense the pills, the smartphone automatically connects to the hardware circuit via a Bluetooth and sends pertinent commands indicating which stepper motor should be rotated and which container to open as shown in Figure 4.

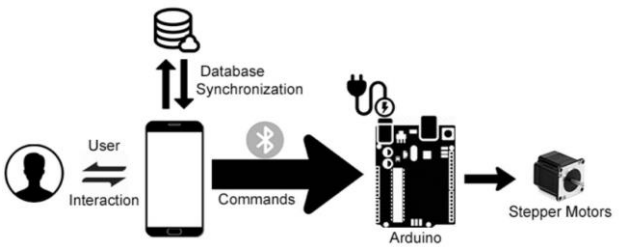

Figure 4. Design Breakdown

A. Android Application Overview

The whole system relies on the android application to provide the user interface, control the medicine dispenser and manage the patient schedule and data.

When the application starts, it shows a login screen where the user is authenticated as shown in Figure 5.

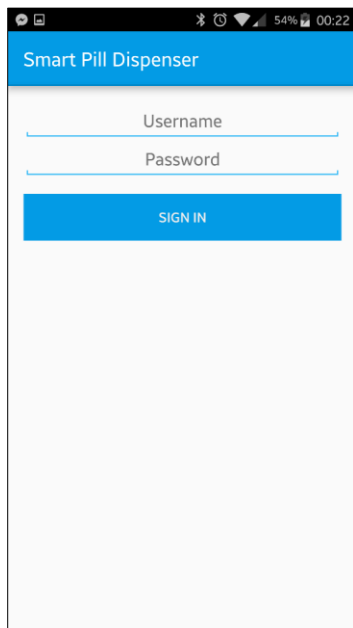

Figure 5. Login Screen

As shown in Figure 6, after the application launches, the username and password screen are displayed on the phone and then the app waits for user input. When the user tries to sign in, the app checks the validity of the credentials and proceeds with the synchronization process only if they are valid.

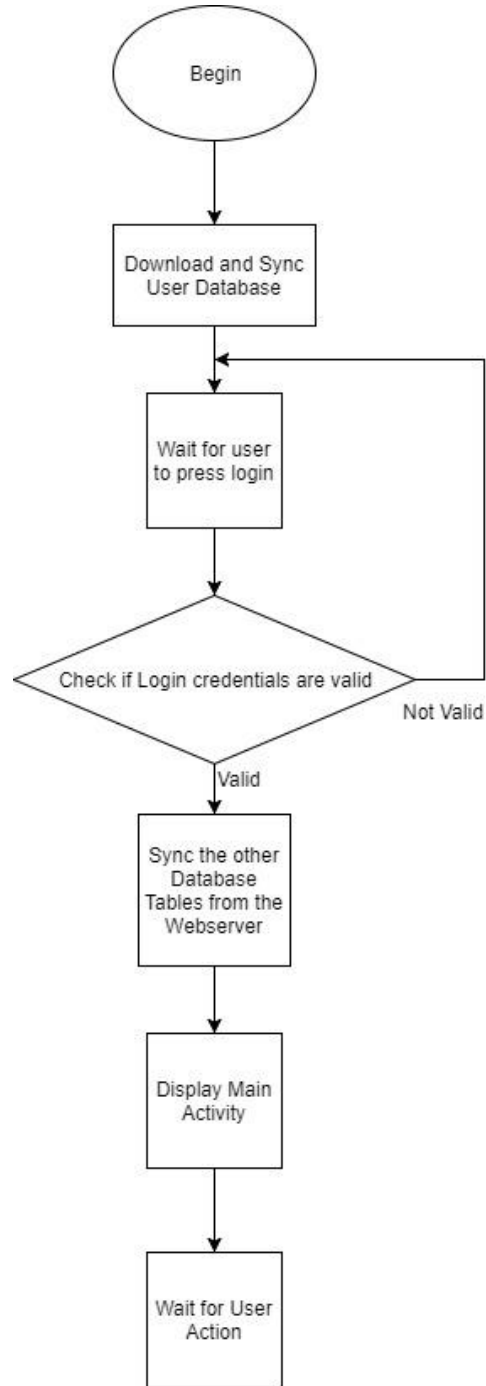

Figure 6. Login Flowchart

After the user logs in, the application will display a list of the pills to be taken on this day and on the next day in another Tab. The app will also provide a history Tab that shows when previous pills were taken as shown in Figures 7, 8 and 9.

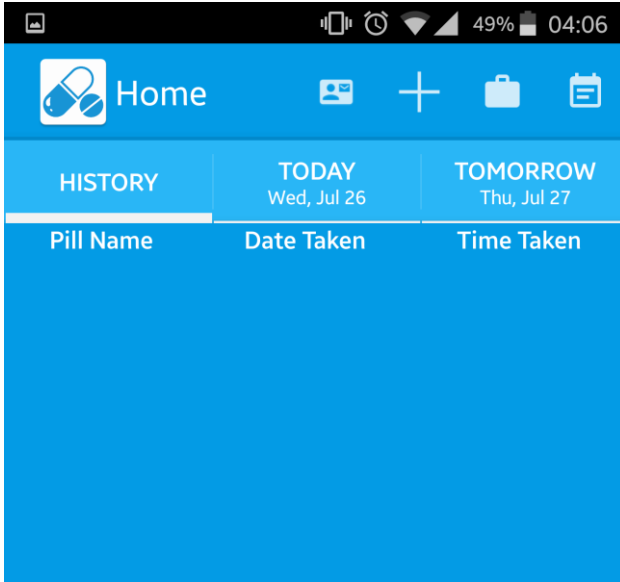

Figure 7. History Tab

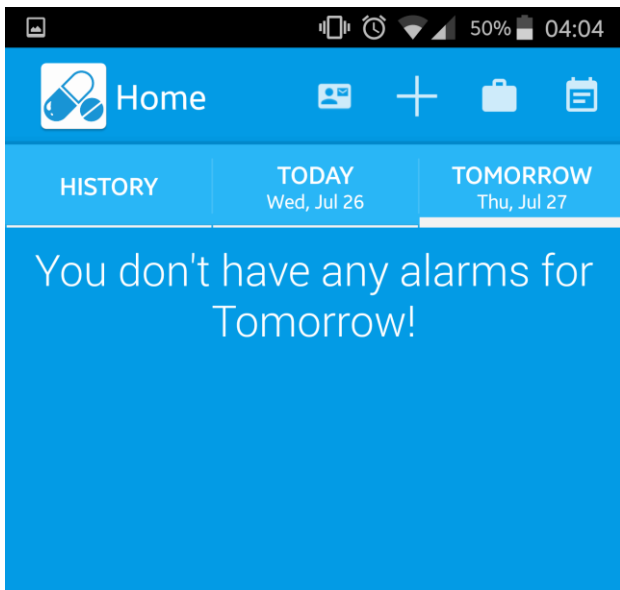

Figure 8: Next day Tab

To add a new pill or an alarm, the user should press on the “Plus” icon and then the pill’s name and time will be displayed; he/she should also specify on what days the alarm should be repeated. The user should also choose in what container (from the connected Pillbox) the pill is to be placed. The Add Alarm view is shown in Figure 10.

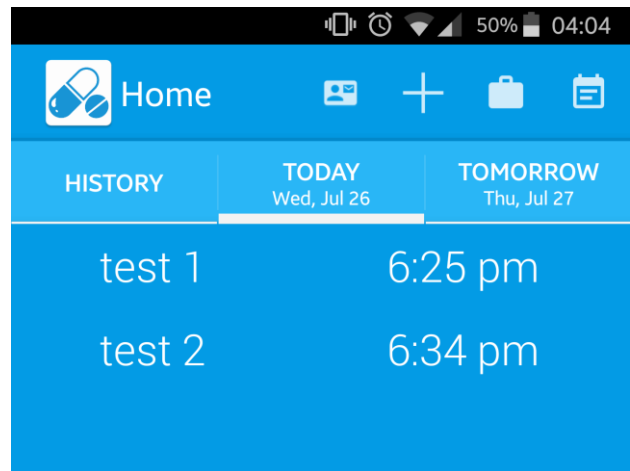

Figure 9. Today Tab

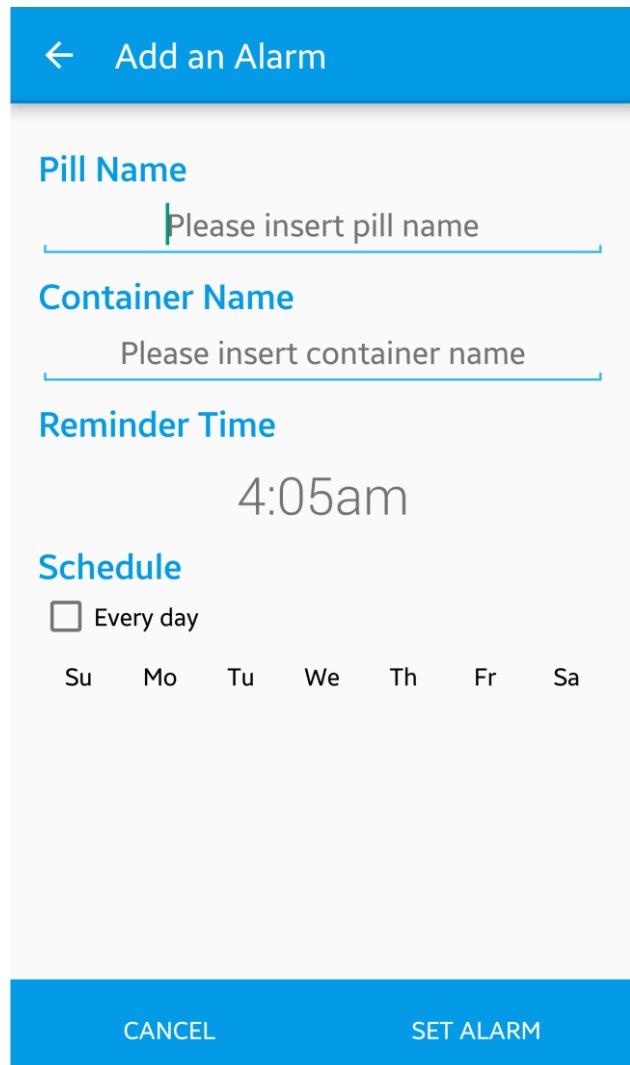

Figure 10. Add Alarm View

As shown in Figure 11, when the “add alarm” button is pressed in the application, the “add alarm” view is launched. The same alarm view activity is used when the user tries to edit an existing alarm but this time the app will load the existing alarm parameters. When the user clicks on “Set Alarm”, the application will validate the parameters (matching pill name, container name, etc.) then it will create a pending alarm activity, followed by the synchronization with the server and updating the local database. If “Cancel” was pressed or the information provided were not valid, the application will notify the user about the error and returns to the main menu.

The application also provides an overview of existing pills with their respective remaining number of pills as shown in Figure 12. The User can select a pill timer to change it or delete it. If he/she assesses that the remaining pill supply is low, he/she can click on the refill button the increase the remaining pills back to 7.

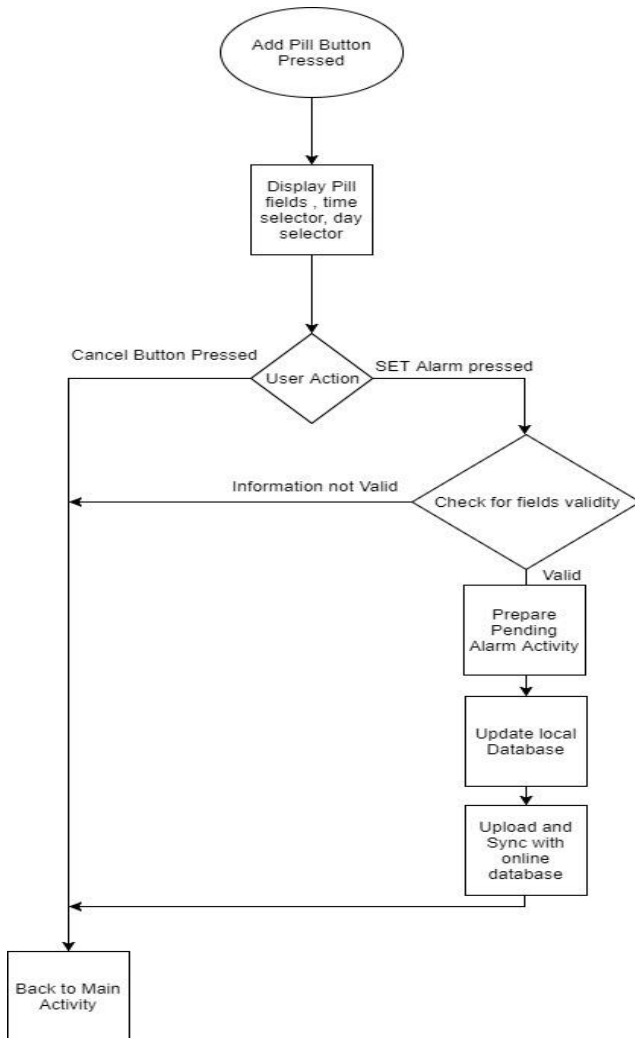

Figure 11. Add Alarm Flowchart

Included in the application is a settings tab where the user can enter his/her Caretaker’s phone number and add new username and password as shown in Figure 13.

When it is time to take the pill, an alarm sound will start and will not stop till the user selects an option of these 3 as shown in Figure 14 and explained in Figure 15:

- Take the pill now: which will check if there are enough pills remaining – if there is enough, it will then dispense the pill in its respective container, and decrease the number of pills remaining in the local database then starts synchronization with the servers. If there aren’t enough pills the application will notify the user and will then snooze the alarm.

- Snooze the pill for 10 minutes then starts synchronization with the servers.

- Or Select to not take the pill, where the application will then alert the phone number holder, saved in the settings, that the patient skipped his/her pill via SMS.

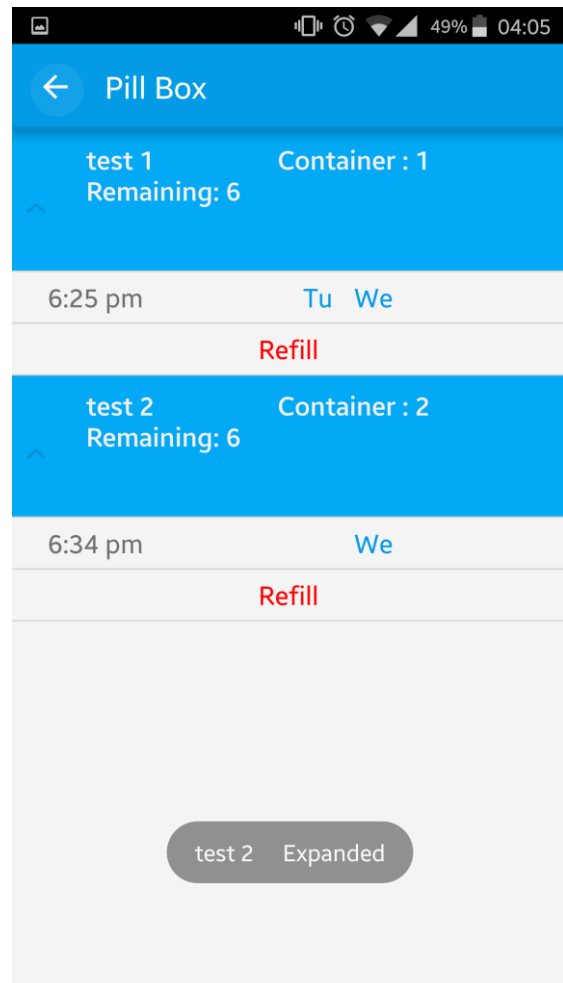

Figure 12. PillBox Overview

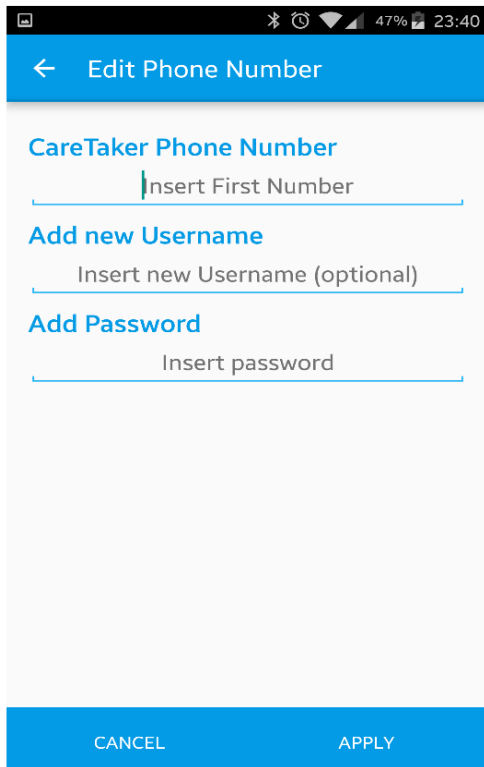

Figure 13. Settings Tab

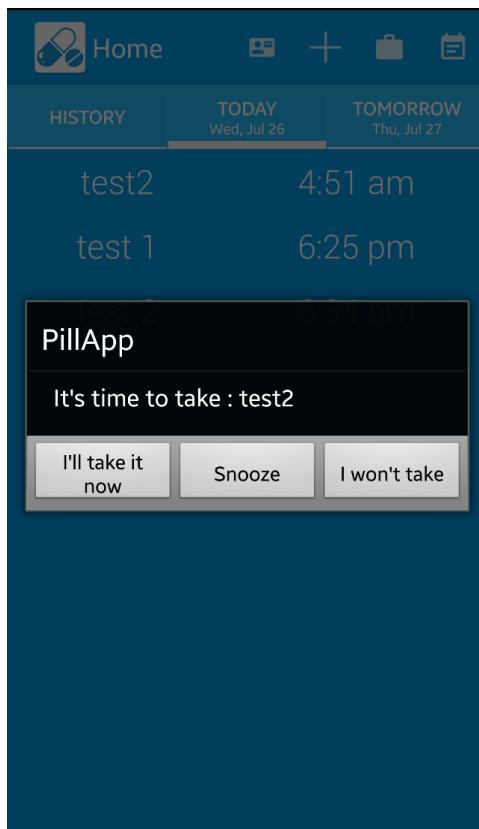

Figure 14. Alarm Popup

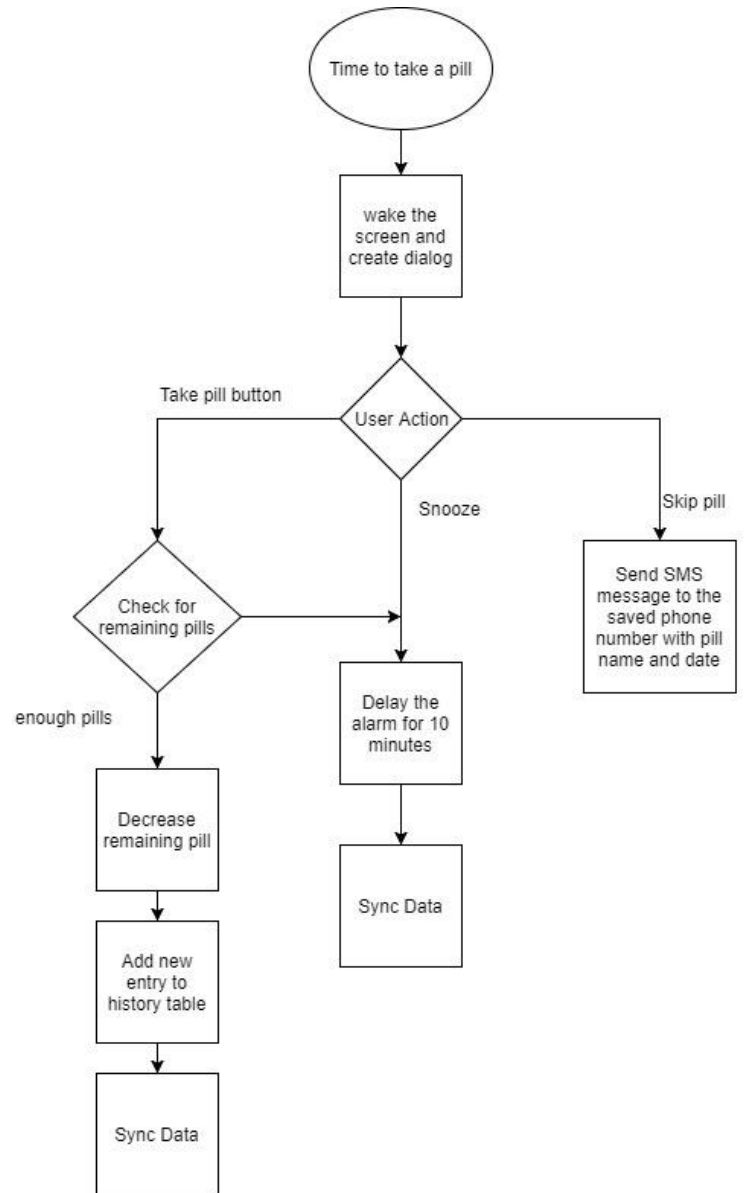

Figure 15. Alarm Flowchart

B. Database Management

The pill alarm system and usage data are stored first locally using SQLite Database. The local database is then synced with an online MySQL Database, hosted on the 000webhost.com servers for free, whenever the user enters the application or changes something in the schedule using PHP and JSON as a way to communicate and transfer data between databases.

C. Packaging and Design

Figure 16 shows the SMD modular as prototype, with expandable container units. Each container is controlled separately with its own LED and can keep up to 7 servings (a serving can consist of multiple pills of the same type). Servo motors are used to rotate the

cylinders; the motors are controlled by an Arduino Uno R3, using PWM signals that make the servo rotate for a bit then stop, and are connected as shown in Figure 17. When the user wants to take his pills, his smartphone will connect to the Arduino via Bluetooth, and sends to which container should be actuated.

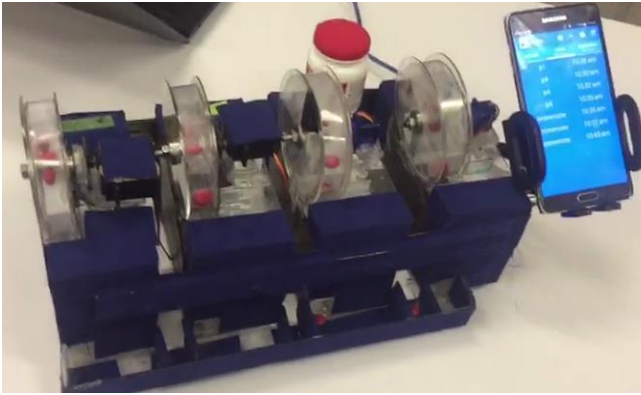

Figure 16. Dispenser Unit Prototype

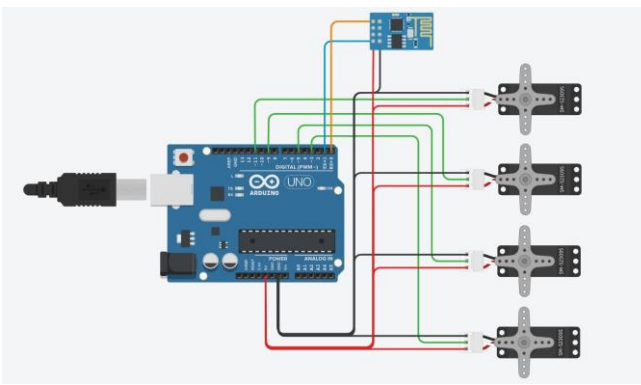

Figure 17. Arduino Connections

The system will then verify if the command is valid by checking if the command string starts with a “c”, the character that comes after the “c” is the container number which will be used to trigger the desired container as shown in figure 18.

4. PRELIMINARY RESULTS

The application was tested multiple times, and demonstrated little to no functionality breaking bugs. The application is very lightweight and has a very low Internet data usage since the local database syncs with the online database only when a change happens or when logging in. The database generated by our tests was captured from our cloud host and shown in figure 19, 20, 21 and 22. Figure 19 shows all registered pills, as an example p4 has an ID of 4, stored in container N°4 and has 6 remaining pills.

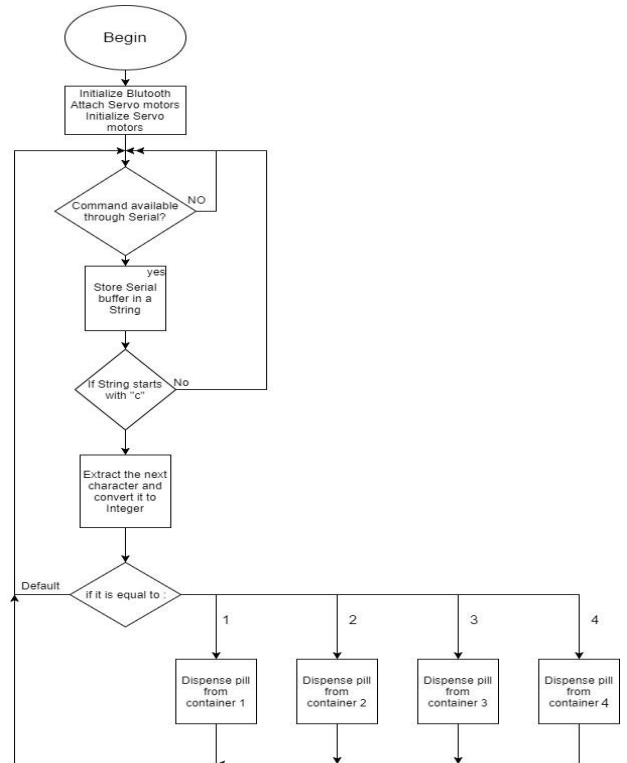

Figure 18. Arduino Code Flowchart

id	pillName	container	remaining
1	testremote	1	5
2	test2	2	8
3	p1	3	8
4	p4	4	6

Figure 19. Existing Pills

Moving to Figure 20, p4 has 3 alarms with IDs 4, 5, 6 that will trigger on the same day and minutes apart for testing purposes. Figure 21 shows the links between pills IDs and alarms IDs, which will keep all tables organized and linked. Figure 22 shows all pills that were taken with their respective names and dates.

Figure 23 shows the text message received by the Caretaker in-case a pill was not taken.

The remote operation features were possible due an Online database (that includes all registered users each with their created Pills, Reminders and medication Logs) that synchronizes all instances of the application together. Figure 24, shows the medication logs that contain information about the date and time of the pills were taken on. While Figure 25 shows the weekly schedule of each pill (day of the week and time) from different users, for example if a pill should be taken 3 times a day and every day, it would then have multiple entries one for each time a pill has to be taken. In Figure 26, all the created pills are stored along with their corresponding container and

amount of pills left in each container, this table also links the pills to their owner's user ID. The Users IDs, usernames and passwords are all stored in one table as shown in Figure 27.

id	pillName	day_of_week	hour	minute
1	testremote	3	18	44
2	test2	3	16	58
3	p1	4	10	28
4	p4	4	10	30
5	p4	4	10	32
6	p4	4	10	33
7	testremote	4	10	36
8	testremote	4	10	37
9	testremote	4	10	43

Figure 20. All Alarm times

id	pill_id	alarm_id
1	1	1
2	2	2
3	3	3
4	4	4
5	4	5
6	4	6
7	1	7
8	1	8
9	1	9

Figure 21. Pill and Alarm Linking

pillName	date	hour	minute
p4	Aug 2, 2017	10	32
p4	Aug 2, 2017	10	33
testremote	Aug 2, 2017	10	36
testremote	Aug 2, 2017	10	37
testremote	Aug 2, 2017	10	43

Figure 22. Dispensed Pills Date and time

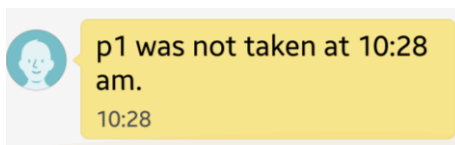

Figure 23. Received SMS Alert

pillName	date	hour	minute
wissam-p2	Apr 6, 2018	8	1
jane-p1	Apr 6, 2018	9	0
smith-p4	Apr 6, 2018	12	11
bob-p3	Apr 6, 2018	9	0

Figure 24. Name and Date of Dispensed Pills

id	pillName	day_of_week	hour	minute
1	wissam-p1	1	18	0
2	wissam-p1	2	18	0
3	wissam-p1	3	18	0
4	wissam-p1	4	18	0
5	wissam-p2	5	8	0
6	wissam-p3	6	9	0
7	wissam-p4	7	12	0
8	john-p1	1	8	0
9	john-p2	2	8	0
10	john-p3	3	8	0
11	john-p4	4	8	0
12	jane-p1	5	9	0
13	jane-p2	6	10	0
14	jane-p3	2	11	0
15	jane-p4	1	12	0
16	smith-p1	2	9	0
17	smith-p2	3	10	0
18	smith-p3	4	11	0
19	smith-p4	5	12	0
20	bob-p1	3	7	0
21	bob-p2	4	8	0
22	bob-p3	5	9	0
23	bob-p4	6	10	0

Figure 25. All the Pill Alarms with their Schedule

id	pillName	container	remaining	userID
1	wissam-p1	1	7	1
2	wissam-p2	2	7	1
3	wissam-p3	3	7	1
4	wissam-p4	4	7	1
5	john-p1	1	7	2
6	john-p2	2	7	2
7	john-p3	3	7	2
8	john-p4	4	7	2
9	jane-p1	1	7	3
10	jane-p2	2	7	3
11	jane-p3	3	7	3
12	jane-p4	4	7	3
13	smith-p1	1	7	4
14	smith-p2	2	7	4
15	smith-p3	3	7	4
16	smith-p4	4	7	4
17	bob-p1	1	7	5
18	bob-p2	2	7	5
19	bob-p3	3	7	5
20	bob-p4	4	7	5

Figure 26. All the Pills with their Containers, the Remaining Pills in each Container and corresponding userID

id	username	password
1	wissam	12345
2	john	12345
3	jane	12345
4	smith	12345
5	bob	12345

Figure 27. Username and Password Database

Hardware testing showed that the dispensing mechanism remained fully accurate after a full container rotation, which is more than enough since the user will have to refill the containers and hence recalibrate them.



5. CONCLUSION

In this paper, a comprehensive approach for smart medicine dispenser (SMD) system was presented. Elderly patients, especially those with chronic diseases and/or periodic medications and checkups, will benefit the most from the SMD, since it will greatly increase their medicine adherence which will ensure a better treatment effectiveness and even save their lives. Insurance and pharmaceutical companies will definitely benefit from the SMD system since it will help their customers live a healthier lifestyle away from life-threatening accidents.

Finally, the user-friendly interface, which is the same on all the devices including the machine, is intuitive, clear and easy to use even by elderly patients. The design is flexible enough to allow users to add more containers or more pills per serving.

REFERENCES

- [1] A. V. Dhukaram and C. Baber, "Elderly Cardiac Patients' Medication Management: Patient Day-to-Day Needs and Review of Medication Management System," *2013 IEEE International Conference on Healthcare Informatics*, pp. 107-114, 2013.
- [2] World Health Organization, <http://www.who.int/medicines/en/>, accessed on July 21, 2017.
- [3] S. L. Gray, J. E. Mahoney, and D. K. Blough, "Medication Adherence in Elderly Patients Receiving Home Health Services following Hospital Discharge." *Annals of Pharmacotherapy*, 35(5), pp. 539-545, 2001.
- [4] C. Fărcaș, I. Ciocan, N. Palaghiță and R. Fizeșan, "Weekly electronic pills dispenser with circular containers," *2015 IEEE 21st International Symposium for Design and Technology in Electronic Packaging (SIITME)*, pp. 125-129, 2015.
- [5] N. B. Othman and O. P. Ek, "Pill dispenser with alarm via smart phone notification," *2016 IEEE 5th Global Conference on Consumer Electronics*, pp. 1-2, 2016.
- [6] S. Chawla, "The autonomous pill dispenser: Mechanizing the delivery of tablet medication," *2016 IEEE 7th Annual Ubiquitous Computing, Electronics & Mobile Communication Conference (UEMCON)*, pp. 1-4, 2016.
- [7] K. Ranjith and R. Mahalaxmi, "Pharmaceutical mini tablets," *International Journal of PharmTech Research*. 7. 507-515, 2015
- [8] A. Alexan, A. Osan and S. Oniga, "Advanced Medication Dispenser," *Carpathian Journal of Electronic and Computer Engineering*, vol. 6, no. 2, pp. 26-31, 2013
- [9] M. Bowsher, "The Automated Pill Dispenser project – the right pills at the right time delivering the right outcomes,". End project evaluation report. West Midlands [Walsall]: Improvement and Efficiency West Midlands, March 2012, 53p.
- [10] P. H. Tsai, T. Y. Chen, C. R. Yu, C. S. Shih and J. W. S. Liu, "Smart Medication Dispenser: Design, Architecture and Implementation," in *IEEE Systems Journal*, vol. 5, no. 1, pp. 99-110, March 2011.
- [11] JuGeon Pak and KeeHyun Park, "Construction of a Smart Medication Dispenser with High Degree of Scalability and Remote Manageability," *Journal of Biomedicine and Biotechnology*, vol. 2012, Article ID 381493, 10 pages, 2012. doi:10.1155/2012/381493
- [12] Epill.com. (2017). e-pill MedTime STATION Automatic Pill Dispenser. [online] Available at: <https://www.epill.com/epillstation.html> [Accessed 24 Nov. 2017].
- [13] W. Antoun, A. Abdo, S. Al-Yaman, A. Kassem, M. Hamad, and C. El Moucary, "Smart Medicine Dispenser (SMD)," the 4th IEEE Middle East Conference on Biomedical Engineering, MECBME 2018, pp. 20–23, 2018.



Wissam Antoun received his Bachelor in Computer and Communication Engineering at Notre Dame University-Louaize in 2017, and he is enrolled at the American University of Beirut continuing his master degree in Computer & Communication Engineering.



Abdallah Kassem (S'98–M'02–SM'11) received his B.S. in Microelectronics from University of Quebec in Montreal in 1992, his M.Sc. and Ph.D. in microelectronics from Ecole Polytechnique de Montreal in 1996 and 2004 respectively. From 1996 to 2000, he taught some courses and laboratories, as instructor, in his field at AUB, LAU in Lebanon. Dr. Kassem joined Notre Dame University in Lebanon as an

assistant professor in the Electrical and Computer Engineering department. He was promoted to the rank of associate professor in 2011. Dr. Kassem published approximately 60 papers in reviewed journals and conference proceedings in Lebanon and around the world. He is an Associate Editor in IEEE ACCESS, a Guest Editor Elsevier, AEU - International Journal of Electronics and Communications. Dr. Kassem was a member of the organized committee of many international conferences sponsored or technically co-sponsored by IEEE (DINWC 2018, EBECEGC 2018, ICM, ICABME, MECBME, ACTEA, ICDIPC 2016, EECEA 2016, DICTAP 2015, TAECE 2015, ICABME 2015, ICeND2014, MELECON). Dr. Kassem was invited as keynote speaker in some conferences and workshops. His research interests include microelectronics design and testing, VLSI, semiconductor device modeling and simulation, microprocessors, engineering education/management, ultrasonic applications, healthcare applications, biomedical system design, smart medical devices e-Health and m-Health.



Chady El Moucary received a Bachelor in Electrical and Electronics Engineering from the Lebanese University then pursued his DEA and PhD at the University of Paris XI in 1997 and 2000. Currently he is an associate professor at Notre Dame University-Louaize and the coordinator of the faculty of engineering at the North Lebanon Campus. He is an active member of the Order of Engineers and Architects since 1997. He is a reviewer for various well-known conferences and journals. His research interests involve machine control, data mining, signal processing and other related fields.



Mustapha Hamad earned a BS degree and an MS degree in electrical engineering in 1989 and 1991 respectively, and a Ph.D. degree in microelectronics in 1995 all from the University of South Florida, Tampa. He joined the faculty of engineering at Notre Dame University in October 1997 as an assistant professor in the department of Electrical Computer and Communication

Engineering (ECCE). His research interests include microelectronics

design and test, VLSI, semiconductor device modeling and simulation, and engineering education. Currently, Dr. Hamad teaches courses in the area of electronics (analog and digital) and is the coordinator for several fundamental courses in the ECCE department. He authored and co-authored a number of articles published in refereed journals and conferences.